

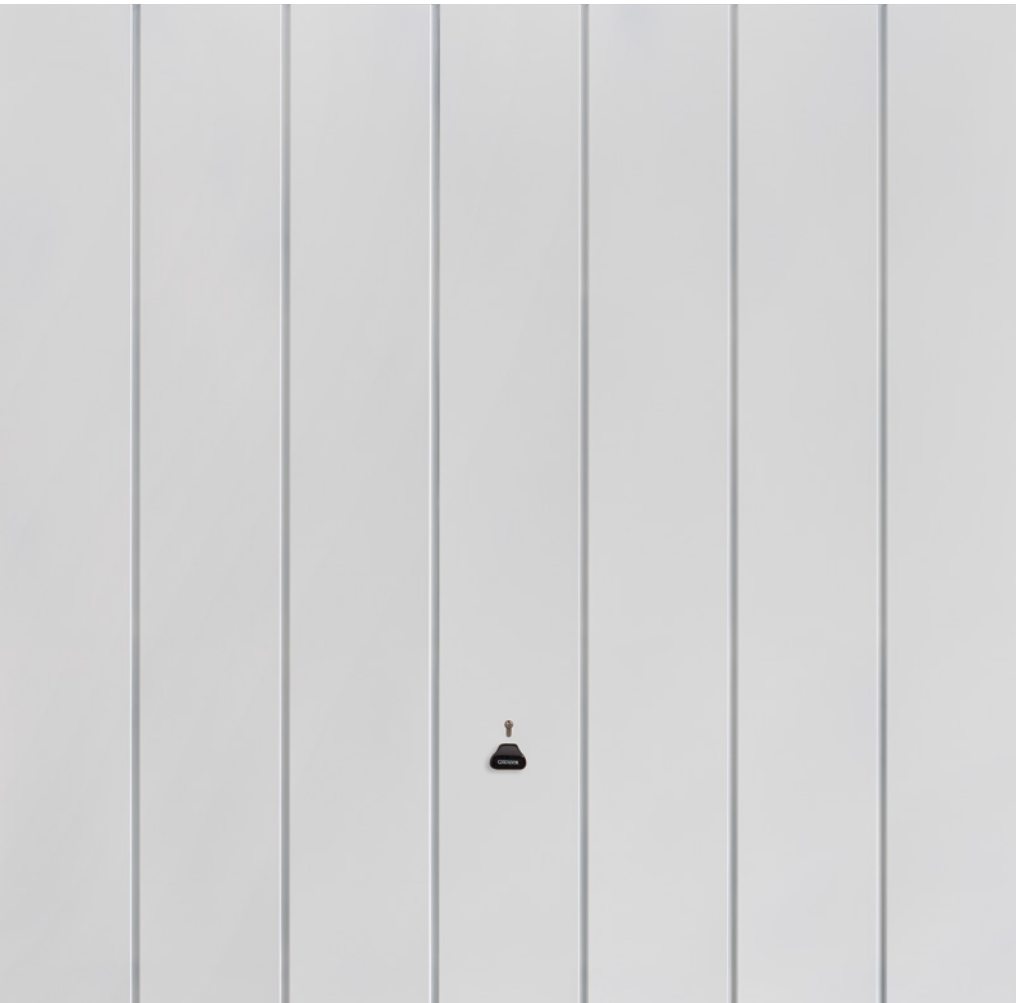

The Garador Range Price List

1st April 2024 Garage Doors and Automatic Operators



General Information

All prices are quoted in £ Sterling, ex-works and exclusive of VAT.

Our doors are for residential purposes only and not for commercial use.

Please ensure that you order the correct size door to fit your opening as we are unable to accept the return of incorrectly ordered goods. Please contact Garador on 01935 443722 if you need assistance in calculating the correct size. A comprehensive range of the less common accessories and all spare parts are available either online or ask for a current spares price list if required.

Since the company's policy is one of continuous improvement of its products, we reserve the right to make any alterations in design, manufacture or price.

All business is governed by the Company's Standard Conditions and this document does not form any part of any contract with the company and statements contained in it should not be construed as representations or warranties.

For more information please visit www.garador.co.uk



Contents

Frame Dimensions for Panel Doors	4
Steel Panel Doors	6
Guardian Range	16
Design Range	18
GRP Premier Panel Doors	20
Timber Panel Doors	26
Steel and Timber Garage Side Doors	36
Steel, Timber and GRP Side-hinged Doors	38
Garage Side Doors & Side-hinged Doors – Specifications	45
Steel Panel Doors – Specifications	46
Steel Sectional Garage Doors	48
Automation and Accessories	72
GaraRoll Roller Doors	78
GaraGlide Roller Doors	82
User Information / Care	86
Warranty	88
Extracts from DHF consumer advice	90

Frame Dimensions for Panel Doors

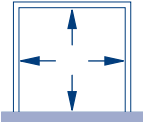
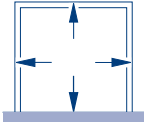
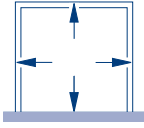
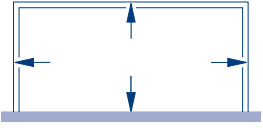
Size Code				
	Internal frame size On-site timber frame Width x Height (mm x mm)	Pre-framed canopy door overall frame sizes shown ¹ Width x Height (mm x mm)	Pre-framed retractable door overall frame sizes shown ¹ Width x Height (mm x mm)	Frame kit for double door overall frame sizes shown ¹ Width x Height (mm x mm)
6660	1984 x 1830	2094 x 1888	2124 x 1888	-
6663	1984 x 1905	2094 x 1963	2124 x 1963	-
6664	1984 x 1931	2094 x 1989	2124 x 1989	-
6666	1984 x 1981	2094 x 2039	2124 x 2039	-
6670	1984 x 2136	2094 x 2194	2124 x 2194	-
61064	2084 x 1931	2194 x 1989	2224 x 1989	-
61066	2084 x 1981	2194 x 2039	2224 x 2039	-
61070	2084 x 2136	2194 x 2194	2224 x 2194	-
7060	2134 x 1830	2244 x 1888	2274 x 1888	-
7063	2134 x 1905	2244 x 1963	2274 x 1963	-
7064	2134 x 1931	2244 x 1989	2274 x 1989	-
7066	2134 x 1981	2244 x 2039	2274 x 2039	-
7068	2134 x 2036	2244 x 2094	2274 x 2094	-
7070	2134 x 2136	2244 x 2194	2274 x 2194	-
7072	2134 x 2186	-	2274 x 2244	-
7076	2134 x 2286	-	2274 x 2344	-
7163	2170 x 1905	2280 x 1963	2310 x 1963	-
7164	2170 x 1931	2280 x 1989	2310 x 1989	-
7166	2170 x 1981	2280 x 2039	2310 x 2039	-
7168	2170 x 2036	2280 x 2094	2310 x 2094	-
7170	2170 x 2136	2280 x 2194	2310 x 2194	-
7172	2170 x 2186	-	2310 x 2244	-
7176	2170 x 2286	-	2310 x 2344	-
7364	2224 x 1931	2334 x 1989	2364 x 1989	-
7366	2224 x 1981	2334 x 2039	2364 x 2039	-
7368	2224 x 2036	2334 x 2094	2364 x 2094	-
7370	2224 x 2136	2334 x 2194	2364 x 2194	-
7563	2259 x 1905	2369 x 1963	2399 x 1963	-
7564	2259 x 1931	2369 x 1989	2399 x 1989	-
7566	2259 x 1981	2369 x 2039	2399 x 2039	-
7568	2259 x 2036	2369 x 2094	2399 x 2094	-
7570	2259 x 2136	2369 x 2194	2399 x 2194	-
7572	2259 x 2186	-	2399 x 2244	-
7576	2259 x 2286	-	2399 x 2344	-
7663	2284 x 1905	2394 x 1963	2424 x 1963	-
7664	2284 x 1931	2394 x 1989	2424 x 1989	-
7666	2284 x 1981	2394 x 2039	2424 x 2039	-
7668	2284 x 2036	2394 x 2094	2424 x 2094	-
7670	2284 x 2136	2394 x 2194	2424 x 2194	-
7672	2284 x 2186	-	2424 x 2244	-
7676	2284 x 2286	-	2424 x 2344	-
8063	2439 x 1905	2549 x 1963	2579 x 1963	-
8064	2439 x 1931	2549 x 1989	2579 x 1989	-
8066	2439 x 1981	2549 x 2039	2579 x 2039	-
8068	2439 x 2036	2549 x 2094	2579 x 2094	-
8070	2439 x 2136	2549 x 2194	2579 x 2194	-

¹ No fitting clearance allowed. If door is fitted between the brickwork a minimum of 10 mm clearance over the width and 5 mm over the height should be added to the overall frame size when selecting the door.

GARADOR *Frame Dimensions for Panel Doors*

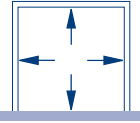
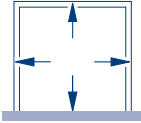
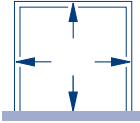
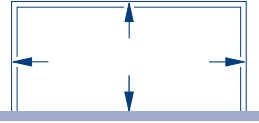
Size Code	 Internal frame size On-site timber frame Width x Height (mm x mm)	 Pre-framed canopy door overall frame sizes shown ¹ Width x Height (mm x mm)	 Pre-framed retractable door overall frame sizes shown ¹ Width x Height (mm x mm)	 Frame kit for double door overall frame sizes shown ¹ Width x Height (mm x mm)
8072	2439 x 2186	–	2579 x 2244	–
8076	2439 x 2286	–	2579 x 2344	–
8666	2590 x 1981	–	2730 x 2039	–
8670	2590 x 2136	–	2730 x 2194	–
8676	2590 x 2286	–	2730 x 2344	–
9066	2744 x 1981	–	2884 x 2039	–
9070	2744 x 2136	–	2884 x 2194	–
9076	2744 x 2286	–	2884 x 2344	–
1066	3049 x 1981	–	3189 x 2039	–
1070	3049 x 2136	–	3189 x 2194	–
1076	3049 x 2286	–	–	3189 x 2344
1166	3354 x 1981	–	–	3494 x 2039
1170	3354 x 2136	–	–	3494 x 2194
1176	3354 x 2286	–	–	3494 x 2344
1266	3659 x 1981	–	–	3799 x 2039
1270	3659 x 2136	–	–	3799 x 2194
1276	3659 x 2286	–	–	3799 x 2344
1366	3964 x 1981	–	–	4104 x 2039
1370	3964 x 2136	–	–	4104 x 2194
1376	3964 x 2286	–	–	4104 x 2344
1466	4269 x 1981	–	–	4409 x 2039
1470	4269 x 2136	–	–	4409 x 2194
1566	4574 x 1981	–	–	4714 x 2039
1570	4574 x 2136	–	–	4714 x 2194
1666	4879 x 1981	–	–	5019 x 2039
1670	4879 x 2136	–	–	5019 x 2194

¹ No fitting clearance allowed. If door is fitted between the brickwork a minimum of 10 mm clearance over the width and 5 mm over the height should be added to the overall frame size when selecting the door.

Steel Panel Doors

Surface

High quality powder or foil coated finish.

Please note: panel doors are produced with appearance in mind. This may result in some small gaps which could allow water ingress especially in exposed locations.

Colours

All doors supplied in Traffic White (RAL 9016) as standard.

Optional colours available:

- | | | | |
|--------------------------|--------------------------|------------------------------|-----------------------------|
| - Light Ivory (RAL 1015) | - Pigeon Blue (RAL 5014) | - Anthracite Grey (RAL 7016) | - Burgundy Brown |
| - Ruby Red (RAL 3003) | - Moss Green (RAL 6005) | - Terra Brown (RAL 8028) | - Golden Brown |
| - Signal Blue (RAL 5005) | - Fir Green (RAL 6009) | - Jet Black (RAL 9005) | - Chartwell Green (BS 4800) |
| - Steel Blue (RAL 5011) | - Slate Grey (RAL 7015) | - Window Grey (RAL 7040) | - Agate Grey (RAL 7038) |
| - Stone Grey (RAL 7030) | - Light grey (RAL 7035) | | |

Timber effect finishes are available in either a Golden Oak or Rosewood foil coat timber effect.

Handle

Black handle as standard, optional handles are available. Doors can be supplied undrilled and without handle and locking mechanism for use with electric operator (not available on Wentwood or Sherwood doors). This option makes the door purpose made and will therefore increase lead-time, please specify clearly on order.

Terminology

Nominal Door Size: This is the actual door panel size plus the fitting tolerances. The nominal door size should be used for internal dimensions of a timber frame.

Size Code: This has traditionally been used to order doors. This may not be the actual door size.

Stock availability

Prices in bold show stock doors in Traffic White (unless specified) and all other prices relate to non-stock doors.

Packaging

All doors are supplied unwrapped as standard, with optional poly-wrapping available.

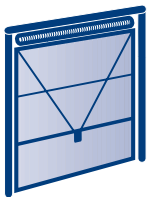

Canopy gearing (shown as C)

Canopy gear is available for all single doors providing a reliable and affordable gearing solution, with no tracks running back into the garage.

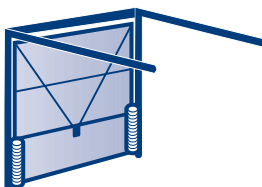

Retractable gearing (shown as R)

Retractable gear is available for all single and double doors providing a reliable and affordable gearing solution, with tracks running back into the garage.

Single door

Nominal Door Size
Width x Height
(mm x mm)

Size
Code

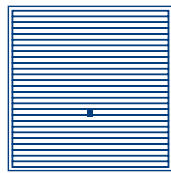

Horizon

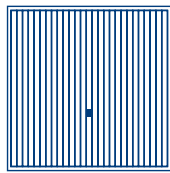

Carlton

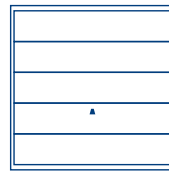

Ascot

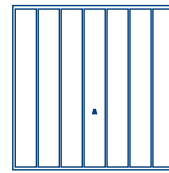

Windsor

	Size Code	Horizon		Carlton		Ascot		Windsor	
		C	R	C	R	C	R	C	R
1984 x 1830	6660	881	930	998	1047	-	-	-	-
1984 x 1905	6663	881	930	998	1047	-	-	-	-
1984 x 1931	6664	881	930	998	1047	-	-	-	-
1984 x 1981	6666	834	883	948	997	-	-	-	-
1984 x 2136	6670	834	883	948	997	947	998	-	-
2084 x 1931	61064	850	899	947	996	-	-	-	-
2084 x 1981	61066	874	923	947	996	997	1046	-	-
2084 x 2136	61070	905	954	968	1017	1018	1067	-	-
2134 x 1830	7060	906	955	1025	1074	-	-	-	-
2134 x 1905	7063	906	955	1025	1074	-	-	-	-
2134 x 1931	7064	861	910	954	1003	-	-	-	-
2134 x 1981	7066	798 ¹	847 ¹	922 ¹	971 ¹	972 ¹	1021 ¹	1136	1185
2134 x 2036	7068	910	959	1008	1057	-	-	1154	1203
2134 x 2136	7070	875 ¹	924 ¹	961 ¹	1010 ¹	1085 ¹	1134 ¹	1172	1221
2134 x 2186	7072	-	993	-	1081	-	-	1243	1292
2134 x 2286	7076	-	1111	-	1192	-	-	-	-
2170 x 1905	7163	861	910	954	1003	-	-	-	-
2170 x 1931	7164	861	910	954	1003	-	-	-	-
2170 x 1981	7166	798	847	922	971	972	1021	1136	1185
2170 x 2036	7168	910	959	1008	1057	-	-	-	-
2170 x 2136	7170	875	924	961	1010	1085	1134	1172	1221
2170 x 2186	7172	-	993	-	1081	-	-	-	-
2170 x 2286	7176	-	1229	-	1295	-	-	-	-
2224 x 1905	7363	938	987	997	1046	-	-	-	-
2224 x 1931	7364	938	987	997	1046	-	-	-	-
2224 x 1981	7366	941	990	1001	1050	1051	1100	-	-
2224 x 2036	7368	980	1029	1063	1112	-	-	-	-
2224 x 2136	7370	955	1004	1014	1063	1064	1113	-	-
2259 x 1905	7563	929	978	1008	1057	-	-	-	-
2259 x 1931	7564	929	978	1008	1057	-	-	-	-
2259 x 1981	7566	938	987	1008	1057	1112	1161	1214	1263
2259 x 2036	7568	980	1029	1063	1112	-	-	1263	1312
2259 x 2136	7570	1065	1114	1135	1184	1263	1312	1313	1362
2259 x 2186	7572	-	1195	-	1223	-	-	-	1449
2259 x 2286	7576	-	1324	-	1295	-	-	-	-
2284 x 1905	7663	938	987	1034	1083	-	-	-	-
2284 x 1931	7664	938	987	1034	1083	-	-	-	-
2284 x 1981	7666	938	987	1034	1083	1112	1161	1214	1263
2284 x 2036	7668	992	1041	1092	1141	-	-	1263	1312
2284 x 2136	7670	1069	1118	1135 ¹	1184 ¹	1247	1296	1313	1362
2284 x 2186	7672	-	1197	-	1266	-	-	-	1449
2284 x 2286	7676	-	1328	-	1295	-	-	-	-
2439 x 1905	8063	1081	1130	1225	1274	-	-	-	-
2439 x 1931	8064	1081	1130	1225	1274	-	-	-	-
2439 x 1981	8066	1081	1130	1225	1274	1238	1287	1409	1458
2439 x 2036	8068	1141	1190	1291	1340	-	-	1429	1478
2439 x 2136	8070	1105	1154	1265 ¹	1314 ¹	1279 ¹	1328 ¹	1449	1498
2439 x 2186	8072	-	1233	-	1406	-	-	-	1586
2439 x 2286	8076	-	1296	-	1410	-	-	-	-
2590 x 1981	8666	-	1247	-	1406	-	-	-	-
2590 x 2136	8670	-	1291	-	1463	-	-	-	-
2590 x 2286	8676	-	1424	-	1590	-	-	-	-
2744 x 1981	9066	-	1491	-	1509	-	-	-	-
2744 x 2136	9070	-	1566	-	1590	-	-	-	-
2744 x 2286	9076	-	1626	-	1649	-	-	-	-
3049 x 1981	1066	-	1757	-	1695	-	-	-	-
3049 x 2136	1070	-	1779	-	1714	-	-	-	-

Stock doors also available in Jet Black (based on RAL 9005).

¹ Stock doors also available in Anthracite Grey (RAL 7016)

For further options please see page 15.

Single door

Nominal Door Size
Width x Height
(mm x mm)

Size
Code

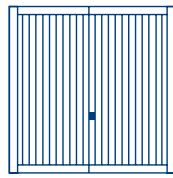

Sutton

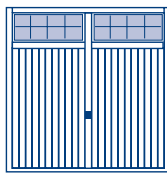

Salisbury ¹

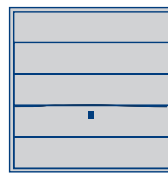

Wentwood
Timber Effect

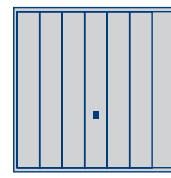

Sherwood
Timber Effect

Nominal Door Size Width x Height (mm x mm)	Size Code	Sutton		Salisbury ¹		Wentwood Timber Effect		Sherwood Timber Effect	
		C	R	C	R	C	R	C	R
1984 x 1830	6660	-	-	-	-	-	-	-	-
1984 x 1905	6663	-	-	-	-	-	-	-	-
1984 x 1931	6664	-	-	-	-	-	-	-	-
1984 x 1981	6666	-	-	-	-	-	-	-	-
1984 x 2136	6670	-	-	-	-	-	-	-	-
2084 x 1931	61064	-	-	-	-	-	-	-	-
2084 x 1981	61066	-	-	-	-	-	-	-	-
2084 x 2136	61070	-	-	-	-	-	-	-	-
2134 x 1830	7060	-	-	-	-	-	-	-	-
2134 x 1905	7063	-	-	-	-	-	-	-	-
2134 x 1931	7064	1041	1090	1584	1633	-	-	-	-
2134 x 1981	7066	986	1035	1584	1633	1026	1075	1190	1239
2134 x 2036	7068	-	-	1669	1718	-	-	-	-
2134 x 2136	7070	1051	1100	1602	1651	1139	1188	1225	1274
2134 x 2186	7072	-	-	-	1744	-	-	-	-
2134 x 2286	7076	-	-	-	-	-	-	-	-
2170 x 1931	7164	-	-	1584	1633	-	-	-	-
2170 x 1981	7166	-	-	1584	1633	-	-	-	-
2170 x 2036	7168	-	-	1669	1718	-	-	-	-
2170 x 2136	7170	-	-	1602	1651	-	-	-	-
2170 x 2186	7172	-	-	-	1744	-	-	-	-
2170 x 2286	7176	-	-	-	-	-	-	-	-
2224 x 1931	7364	-	-	1647	1696	-	-	-	-
2224 x 1981	7366	-	-	1647	1696	-	-	-	-
2224 x 2136	7370	-	-	1663	1712	-	-	-	-
2259 x 1931	7564	1142	1191	1647	1696	-	-	-	-
2259 x 1981	7566	1142	1191	1647	1696	-	-	-	-
2259 x 2036	7568	-	-	1733	1782	-	-	-	-
2259 x 2136	7570	1258	1307	1663	1712	-	-	-	-
2259 x 2186	7572	-	-	-	1805	-	-	-	-
2259 x 2286	7576	-	-	-	-	-	-	-	-
2284 x 1931	7664	1155	1204	1647	1696	-	-	-	-
2284 x 1981	7666	1097	1146	1647	1696	1166	1215	1266	1315
2284 x 2036	7668	-	-	1733	1782	-	-	-	-
2284 x 2136	7670	1211	1260	1663 ²	1712 ²	1298	1347	1368	1417
2284 x 2186	7672	-	-	-	1805	-	-	-	-
2284 x 2286	7676	-	-	-	-	-	-	-	-
2439 x 1931	8064	1272	1321	1749	1798	-	-	-	-
2439 x 1981	8066	1272	1321	1749	1798	1290	1339	1459	1508
2439 x 2036	8068	-	-	1835	1884	-	-	-	-
2439 x 2136	8070	1295	1344	1764	1813	1336	1385	1505	1557
2439 x 2186	8072	-	-	-	1906	-	-	-	-
2439 x 2286	8076	-	-	-	-	-	-	-	-
2590 x 1981	8666	-	-	-	-	-	-	-	-
2590 x 2136	8670	-	-	-	-	-	-	-	-
2590 x 2286	8676	-	-	-	-	-	-	-	-
2744 x 1981	9066	-	-	-	-	-	-	-	-
2744 x 2136	9070	-	-	-	-	-	-	-	-
2744 x 2286	9076	-	-	-	-	-	-	-	-
3049 x 1981	1066	-	-	-	-	-	-	-	-
3049 x 2136	1070	-	-	-	-	-	-	-	-

¹ Salisbury windows (with window icon) come as white as standard, colour match windows are available to order as an option, see page 15.

² Also available on 1 week lead time in Jet Black (RAL 9005) with black colour match windows.

Please note that doors with windows may have cross bracing or locking rods passing behind the windows depending upon size and gear type.

Stock doors also available in Jet Black (based on RAL 9005).

Wentwood and Sherwood models are only available in either a Golden Oak or Rosewood foil coat timber effect finish.

For further options please see page 15.

Single door

Nominal Door Size
Width x Height
(mm x mm)

Size
Code

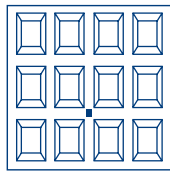

Georgian

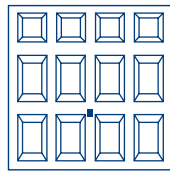

Beaumont

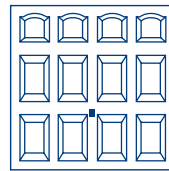

Cathedral

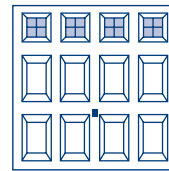

Beaumont with
Windows¹

Nominal Door Size Width x Height (mm x mm)	Size Code	Georgian		Beaumont		Cathedral		Beaumont with Windows ¹	
		C	R	C	R	C	R	C	R
1984 x 1830	6660	-	-	-	-	-	-	-	-
1984 x 1905	6663	-	-	-	-	-	-	-	-
1984 x 1931	6664	1220	1269	1220	1269	1220	1269	1661	1710
1984 x 1981	6666	1156	1205	1156	1205	1156	1205	1667	1716
1984 x 2136	6670	1173	1222	1173	1222	1173	1222	1613	1662
2084 x 1931	61064	1169	1218	1169	1218	1169	1218	1609	1658
2084 x 1981	61066	1171	1220	1171	1220	1171	1220	1611	1660
2084 x 2136	61070	1256	1305	1256	1305	1256	1305	1694	1743
2134 x 1830	7060	-	-	-	-	-	-	-	-
2134 x 1905	7063	-	-	-	-	-	-	-	-
2134 x 1931	7064	1171	1220	1171	1220	1171	1220	1611	1660
2134 x 1981	7066	1171	1220	1171	1220	1171	1220	1611	1660
2134 x 2136	7070	1241	1290	1241	1290	1241	1290	1678	1727
2134 x 2286	7076	-	1476	-	1476	-	1476	-	1913
2170 x 1931	7164	1171	1220	1171	1220	1171	1220	1611	1660
2170 x 1981	7166	1171	1220	1171	1220	1171	1220	1611	1660
2170 x 2136	7170	1241	1290	1241	1290	1241	1290	1678	1727
2170 x 2286	7176	-	1595	-	1595	-	1595	-	2035
2224 x 1931	7364	1301	1350	1301	1350	1301	1350	1744	1793
2224 x 1981	7366	1308	1357	1308	1357	1308	1357	1750	1799
2224 x 2136	7370	1316	1365	1316	1365	1316	1365	1757	1806
2259 x 1931	7564	1301	1350	1301	1350	1301	1350	1744	1793
2259 x 1981	7566	1301	1350	1301	1350	1301	1350	1744	1793
2259 x 2136	7570	1497	1546	1497	1546	1497	1546	1942	1991
2259 x 2286	7576	-	1818	-	1818	-	1818	-	2257
2284 x 1931	7664	1301	1350	1301	1350	1301	1350	1744	1793
2284 x 1981	7666	1301	1350	1301	1350	1301	1350	1744	1793
2284 x 2136	7670	1497	1546	1497	1546	1497	1546	1942	1991
2284 x 2286	7676	-	1818	-	1818	-	1818	-	2257
2439 x 1931	8064	1540	1589	1540	1589	1540	1589	1981	2030
2439 x 1981	8066	1540	1589	1540	1589	1540	1589	1981	2030
2439 x 2136	8070	1605	1654	1605	1654	1605	1654	2044	2093
2439 x 2286	8076	-	1783	-	1783	-	1783	-	2294
2590 x 1981	8666	-	1643	-	1643	-	1643	-	2151
2590 x 2136	8670	-	1662	-	1662	-	1662	-	2173
2590 x 2286	8676	-	1841	-	1841	-	1841	-	2348
2744 x 1981	9066	-	1667	-	1667	-	1667	-	2180
2744 x 2136	9070	-	1690	-	1690	-	1690	-	2198
2744 x 2286	9076	-	1866	-	1866	-	1866	-	2378
3049 x 1981	1066	-	1730	-	1730	-	1730	-	2243
3049 x 2136	1070	-	1766	-	1766	-	1766	-	2281

¹ Windows for Beaumont: Standard (□), Diamond (◊), Cross (⊕). Please state on order if clear or crystal panes, see page 15.

Please note that doors with windows may have cross bracing or locking rods passing behind the windows depending upon size and gear type.

Stock doors also available in Jet Black (based on RAL 9005).

For further options please see page 15.

Single door

Nominal Door Size
Width x Height
(mm x mm)

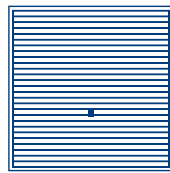

Horizon

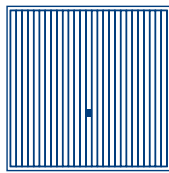

Carlton

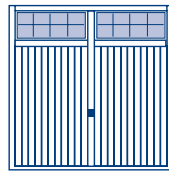

Salisbury

		Horizon		Carlton		Salisbury	
		C	R	C	R	C	R
1830-1930	x 1830-1930	1162	1211	1206	1255	-	-
1830-1930	x 1931-1981	1205	1254	1250	1299	-	-
1830-1930	x 1982-2136	1296	1345	1323	1372	-	-
1830-1930	x 2137-2286	-	1458	-	1507	-	-
1830-1930	x 2287-2439	-	-	-	1605	-	-
1931-1984	x 1830-1930	1169	1218	1220	1269	-	-
1931-1984	x 1931-1981	1213	1262	1261	1310	-	-
1931-1984	x 1982-2136	1287	1336	1328	1377	-	-
1931-1984	x 2137-2286	-	1458	-	1507	-	-
1931-1984	x 2287-2439	-	1564	-	1605	-	-
1985-2134	x 1830-1930	1213	1262	1259	1308	-	-
1985-2134	x 1931-1981	1287	1336	1328	1377	-	-
1985-2134	x 1982-2136	1389	1438	1415	1464	-	-
1985-2134	x 2137-2286	-	1564	-	1605	-	-
1985-2134	x 2287-2439	-	1662	-	1692	-	-
2135-2284	x 1830-1930	1287	1336	1312	1361	-	-
2135-2284	x 1931-1981	1389	1438	1415	1464	-	-
2135-2284	x 1982-2136	1476	1525	1523	1572	1900	2147
2135-2284	x 2137-2286	-	1662	-	1692	-	-
2135-2284	x 2287-2439	-	1765	-	1809	-	-
2285-2499 ¹	x 1830-1930	1389	1438	1430	1479	-	-
2285-2499 ¹	x 1931-1981	1476	1525	1523	1572	-	-
2285-2499 ¹	x 1982-2136	1487	1536	1605	1654	2098	2147
2285-2499	x 2137-2286	-	1695	-	1730	-	-
2285-2499	x 2287-2439	-	1766	-	1784	-	-
2500-2590	x 1830-1930	-	1590	-	1618	-	-
2500-2590	x 1931-1981	-	1662	-	1692	-	-
2500-2590	x 1982-2136	-	1766	-	1766	-	-
2500-2590	x 2137-2286	-	1784	-	1784	-	-
2500-2590	x 2287-2439	-	1893	-	1893	-	-
2591-2722	x 1830-1930	-	1690	-	1690	-	-
2591-2722	x 1931-1981	-	1757	-	1757	-	-
2591-2722	x 1982-2136	-	1879	-	1879	-	-
2591-2722	x 2137-2286	-	1997	-	1997	-	-
2591-2722	x 2287-2439	-	2129	-	2129	-	-
2723-3049	x 1830-1930	-	-	-	2056	-	-
2723-3049	x 1931-1981	-	-	-	2128	-	-
2723-3049	x 1982-2136	-	-	-	2344	-	-

¹ Canopy gear only available up to 2439 wide.

Orders for purpose made sizes will only be accepted as nominal door size for unframed version and overall frame size when ordering a framed version. Orders for purpose made framed doors will not be accepted as nominal door size.

For further options please see page 15.

Single door

Nominal Door Size
Width x Height
(mm x mm)

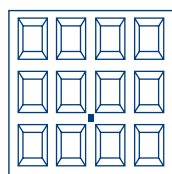

Georgian

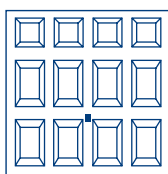

Beaumont

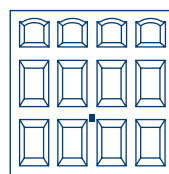

Cathedral

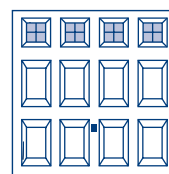

Beaumont with Windows²

		Georgian		Beaumont		Cathedral		Beaumont with Windows ²	
		C	R	C	R	C	R	C	R
1830-1930	x 1830-1930	-	-	-	-	-	-	-	-
1830-1930	x 1931-1981	-	-	-	-	-	-	-	-
1830-1930	x 1982-2136	-	-	-	-	-	-	-	-
1830-1930	x 2137-2286	-	-	-	-	-	-	-	-
1830-1930	x 2287-2439	-	-	-	-	-	-	-	-
1931-1984	x 1830-1930	-	-	-	-	-	-	-	-
1931-1984	x 1931-1981	-	-	-	-	-	-	-	-
1931-1984	x 1982-2136	-	-	-	-	-	-	-	-
1931-1984	x 2137-2286	-	-	-	-	-	-	-	-
1931-1984	x 2287-2439	-	-	-	-	-	-	-	-
1985-2134	x 1830-1930	-	-	-	-	-	-	-	-
1985-2134	x 1931-1981	1829	1878	1829	1878	1829	1878	2268	2317
1985-2134	x 1982-2136	1943	1992	1943	1992	1943	1992	2383	2432
1985-2134	x 2137-2286	-	2134	-	2134	-	2134	-	2574
1985-2134	x 2287-2439	-	2058	-	2058	-	2058	-	2498
2135-2284	x 1830-1930	-	-	-	-	-	-	-	-
2135-2284	x 1931-1981	1959	2008	1959	2008	1959	2008	2401	2450
2135-2284	x 1982-2136	1959	2008	1959	2008	1959	2008	2401	2450
2135-2284	x 2137-2286	-	2114	-	2114	-	2114	-	2557
2135-2284	x 2287-2439	-	2407	-	2407	-	2407	-	2847
2285-2499 ¹	x 1830-1930	-	-	-	-	-	-	-	-
2285-2499 ¹	x 1931-1981	2078	2127	2078	2127	2078	2127	2522	2571
2285-2499 ¹	x 1982-2136	2113	2162	2113	2162	2113	2162	2556	2605
2285-2499	x 2137-2286	-	2249	-	2249	-	2249	-	2690
2285-2499	x 2287-2439	-	2340	-	2340	-	2340	-	2780
2500-2590	x 1830-1930	-	-	-	-	-	-	-	-
2500-2590	x 1931-1981	-	2230	-	2230	-	2230	-	2671
2500-2590	x 1982-2136	-	2265	-	2265	-	2265	-	2708
2500-2590	x 2137-2286	-	2317	-	2317	-	2317	-	2759
2500-2590	x 2287-2439	-	2393	-	2393	-	2393	-	2830
2591-2722	x 1830-1930	-	-	-	-	-	-	-	-
2591-2722	x 1931-1981	-	2239	-	2239	-	2239	-	2680
2591-2722	x 1982-2136	-	2345	-	2345	-	2345	-	2790
2591-2722	x 2137-2286	-	2416	-	2416	-	2416	-	2859
2591-2722	x 2287-2439	-	-	-	-	-	-	-	-
2723-3049	x 1830-1930	-	-	-	-	-	-	-	-
2723-3049	x 1931-1981	-	2393	-	2393	-	2393	-	2830
2723-3049	x 1982-2136	-	2482	-	2482	-	2482	-	2922

¹ Canopy gear only available up to 2439 wide.

² Windows for Beaumont: Standard (□), Diamond (◊), Cross (⊕). Please state on order if clear or crystal panes.

Orders for purpose made sizes will only be accepted as nominal door size for unframed version and overall frame size when ordering a framed version. Orders for purpose made framed doors will not be accepted as nominal door size.

Please note that doors with windows may have cross bracing or locking rods passing behind the windows depending upon size and gear type.

For further options please see page 15.

Double door

Nominal Door Size
Width x Height
(mm x mm)

Size
Code

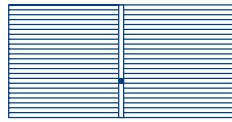

Horizon

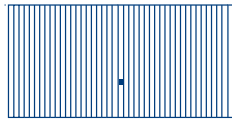

Carlton

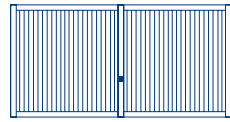

Sutton

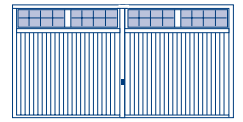

Salisbury

		R	R	R	R
3049 x 2286	1076	2275	2275	-	-
3354 x 1981	1166	2128	2128	-	-
3354 x 2136	1170	2144	2144	-	-
3354 x 2286	1176	2199	2199	-	-
3659 x 1981	1266	2234	2234	-	-
3659 x 2136	1270	2251	2251	-	-
3659 x 2286	1276	2410	2410	-	-
3964 x 1981	1366	2431	2431	-	-
3964 x 2136	1370	2449	2449	-	-
3964 x 2286	1376	2683	2683	-	-
4269 x 1981	1466	2342	2342	2533	3242
4268 x 2036	1468	-	2342	-	-
4269 x 2136	1470	2342	2342	2533	3242
4268 x 2186	1472	-	2342	-	-
4574 x 1981	1566	2522	2522	2713	-
4574 x 2136	1570	2559	2559	2750	-
4879 x 1981	1666	2667	2667	2858	-
4879 x 2136	1670	2701	2701	2892	-

Double door

Nominal Door Size
Width x Height
(mm x mm)

Size
Code

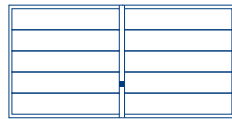

Ascot

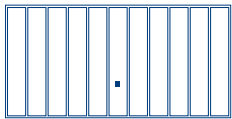

Windsor

		R	R
3049 x 2286	1076	-	-
3354 x 1981	1166	-	-
3354 x 2136	1170	-	-
3354 x 2286	1176	-	-
3659 x 1981	1266	-	-
3659 x 2136	1270	-	-
3659 x 2286	1276	-	-
3964 x 1981	1366	-	-
3964 x 2136	1370	-	-
3964 x 2286	1376	-	-
4269 x 1981	1466	2476	2476
4269 x 2136	1470	2476	2476
4574 x 1981	1566	-	-
4574 x 2136	1570	-	-
4879 x 1981	1666	-	-
4879 x 2136	1670	-	-

Please note that doors with windows may have cross bracing or locking rods passing behind the windows depending upon size and gear type.

For further options please see page 15.

Double door

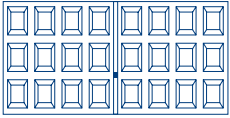
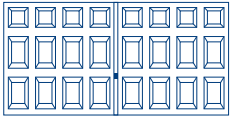
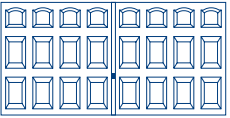
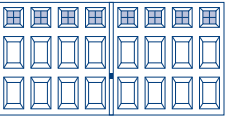
Nominal Door Size Width x Height (mm x mm)	Size Code				
		Georgian	Beaumont	Cathedral	Beaumont with Windows ¹
		R	R	R	R
3049 x 2286	1076	2275	2275	2275	2931
3354 x 1981	1166	2234	2234	2234	2898
3354 x 2136	1170	2234	2234	2234	2898
3354 x 2286	1176	2414	2414	2414	3076
3659 x 1981	1266	2379	2379	2379	3040
3659 x 2136	1270	2379	2379	2379	3040
3659 x 2286	1276	2488	2488	2488	3148
3964 x 1981	1366	2450	2450	2450	3111
3964 x 2136	1370	2450	2450	2450	3111
3964 x 2286	1376	2488	2488	2488	3162
4269 x 1981	1466	2522	2522	2522	3181
4269 x 2136	1470	2522	2522	2522	3181
4574 x 1981	1566	2739	2739	2739	3398
4574 x 2136	1570	2739	2739	2739	3398
4879 x 1981	1666	2881	2881	2881	3545
4879 x 2136	1670	2881	2881	2881	3545

¹ Windows for Beaumont: Standard () , Diamond () , Cross () . Please state on order if clear or crystal panes.

Please note that doors with windows may have cross bracing or locking rods passing behind the windows depending upon size and gear type.

For further options please see page 15.

Double door

Nominal Door Size
Width x Height
(mm x mm)

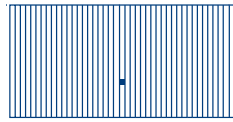

Carlton

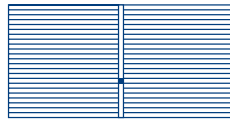

Horizon

	R	R
2745-3049 x 2137-2286	2630	-
3050-3354 x 1886-1981	2488	2522
3050-3354 x 1982-2136	2506	2540
3050-3354 x 2137-2286	2739	2774
3355-3659 x 1886-1981	2559	2594
3355-3659 x 1982-2136	2612	2647
3355-3659 x 2137-2286	2739	2774
3660-3967 x 1886-1981	2792	2828
3660-3967 x 1982-2136	2845	2881
3660-3967 x 2137-2286	3045	3078
3968-4269 x 1886-1981	2701	2739
3968-4269 x 1982-2136	2739	2774
4270-5000 x 1886-1981	2992	3024
4270-5000 x 1982-2136	3062	3098

Double door

Nominal Door Size
Width x Height
(mm x mm)

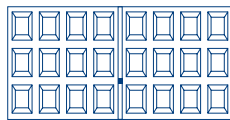

Georgian

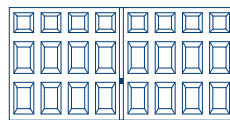

Beaumont

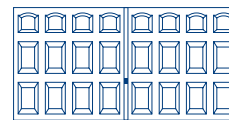

Cathedral

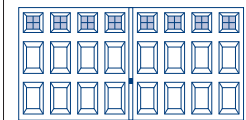

Beaumont with Windows¹

	R	R	R	R
2745-3049 x 2137-2286	2630	2630	2630	3083
3050-3354 x 1931-1981	2594	2594	2594	3257
3050-3354 x 1982-2136	2630	2630	2630	3293
3050-3354 x 2137-2286	2774	2774	2774	3439
3355-3659 x 1931-1981	2739	2739	2739	3398
3355-3659 x 1982-2136	2810	2810	2810	3472
3355-3659 x 2137-2286	2845	2845	2845	3508
3660-3967 x 1931-1981	2810	2810	2810	3688
3660-3967 x 1982-2136	2845	2845	2845	3726
3660-3967 x 2137-2286	2881	2881	2881	3763
3968-4269 x 1931-1981	2881	2881	2881	3763
3968-4269 x 1982-2136	2881	2881	2881	3763
4270-5000 x 1931-1981	3242	3242	3242	4342
4270-5000 x 1982-2136	3242	3242	3242	4342

¹ Windows for Beaumont: Standard (□), Diamond (◊), Cross (⊠). Please state on order if clear or crystal panes.

Orders for purpose made sizes will only be accepted as nominal door size for unframed version and overall frame size when ordering a framed version. Orders for purpose made framed doors will not be accepted as nominal door size.

Please note that doors with windows may have cross bracing or locking rods passing behind the windows depending upon size and gear type. For further options please see page 15.

Options	Single doors	Double doors
	add	add
Factory pre-framed standard single doors	178	-
Steel frame for standard double doors	-	267
Factory pre-framed purpose-made single doors (framed retractable purpose made doors require a 4 week lead-time)	201	-
Steel frame for purpose made double doors	-	297
Additional Lock Kit, C-type/ R-type (fitted onto door)	83	-
Retractable plus gear available on 1931, 1981 and 2136 mm high doors up to 2744 mm wide	85	-
For powder-coated doors ¹ : Moss Green (RAL 6005), Ruby Red (RAL 3003), Signal Blue (RAL 5005), Jet Black (RAL 9005), Steel Blue (RAL 5011), Light Ivory (RAL 1015), Pigeon Blue (RAL 5014), Fir Green (RAL 6009), Anthracite Grey (RAL 7016), Stone Grey (RAL 7030), Light Grey (RAL 7035), Slate Grey (RAL 7015), Agate Grey (RAL 7038), Window Grey (RAL 7040), Chartwell Green (BS 4800), Burgundy Brown ² , Golden Brown ² and Terra Brown (RAL 8028).	176	275
Coloured window frames to match door colour – Beaumont doors (price per window). Beaumont doors up to 3049 wide = 4 windows, between 3050 to 3964 = 6 windows, between 3965 to 4860 = 8 windows and over 4860 = 10 windows ² .	65 each	65 each
Coloured window frames to match door colour – Salisbury doors (price per door) ²	221	434
Black window panes for Salisbury doors (price per door)	50	94
Poly-wrapping	47	86
Diecast metal handles: brass effect, chrome effect, brushed steel and white	98	98
Bottom weatherseal, 2405 mm length (suitable for gaps up to 15 mm between the door and the floor level)	61	61
Bottom weatherseal, 3000 mm length (suitable for gaps up to 15 mm between the door and the floor level)	67	67
Surcharge on White RAL 9016 doors for colour steel frame in RAL colour not matching Garage door	176	275

¹ Please state coloured windows required on order. Coloured Beaumont with windows and Salisbury doors are supplied with white window frames as standard.

² Colour match windows not available in Burgundy Brown or Golden Brown.

Please note that doors with windows may have cross bracing or locking rods passing behind the windows depending upon size and gear type.

Guardian Range

New Secured By Design certified Up & Over doors

These doors have been tested to the STS 202 Security Technical Specification and achieve Secured By Design accreditation. New lock body protection, anti-snap cylinder, high security bracing and improved lock security make these doors even more secure.

Information

Guardian Range doors come with a pre-fitted steel frame and cannot be fitted to a custom made timber frame.

There is no mechanism to unlock Guardian range doors from the inside.

Guardian Range doors are not suitable for automation. Only available with canopy or retractable lifting gear.

Retractable plus not available.

Window panes on Secured by Design Salisbury doors are black non-translucent.

Single door - standard sizes

Nominal Door Size
Width x Height
(mm x mm)

Size
Code

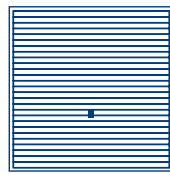

Horizon

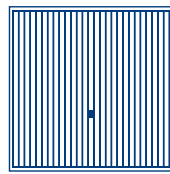

Carlton

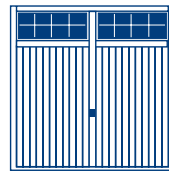

Salisbury

Nominal Door Size Width x Height (mm x mm)	Size Code	Horizon		Carlton		Salisbury	
		C	R	C	R	C	R
1984 x 1830	6660	1483	1532	1606	1655	-	-
1984 x 1905	6663	1483	1532	1606	1655	-	-
1984 x 1931	6664	1483	1532	1606	1655	-	-
1984 x 1981	6666	1442	1491	1557	1606	-	-
1984 x 2136	6670	1458	1507	1557	1606	-	-
2084 x 1931	61064	1458	1507	1557	1606	-	-
2084 x 1981	61066	1478	1527	1557	1606	-	-
2084 x 2136	61070	1509	1558	1573	1622	-	-
2134 x 1830	7060	1511	1560	1630	1679	-	-
2134 x 1905	7063	1511	1560	1630	1679	-	-
2134 x 1931	7064	1465	1514	1560	1609	2193	2242
2134 x 1981	7066	1368	1417	1528	1577	2193	2242
2134 x 2031	7068	1549	1598	1647	1696	-	-
2134 x 2136	7070	1479	1528	1567	1616	2209	2258
2134 x 2186	7072	-	1630	-	1725	-	-
2170 x 1931	7164	1549	1598	1625	1674	-	-
2170 x 1981	7166	1368	1417	1528	1577	-	-
2170 x 2036	7168	1549	1598	1647	1696	-	-
2170 x 2136	7170	1573	1622	1675	1724	-	-
2170 x 2186	7172	-	1642	-	1743	-	-
2224 x 1931	7364	1541	1590	1605	1654	-	-
2224 x 1981	7366	1549	1598	1609	1658	-	-
2224 x 2136	7370	1563	1612	1621	1670	-	-
2259 x 1931	7564	1591	1640	1658	1707	2252	2301
2259 x 1981	7566	1541	1590	1613	1662	2252	2301
2259 x 2036	7568	1673	1722	1741	1790	-	-
2259 x 2136	7570	1673	1722	1741	1790	2268	2317
2259 x 2286	7572	-	1741	-	1810	-	-
2284 x 1931	7664	1541	1590	1642	1691	2252	2301
2284 x 1981	7666	1541	1590	1642	1691	2252	2301
2284 x 2031	7668	1629	1678	1734	1783	-	-
2284 x 2136	7670	1675	1724	1741	1790	2268	2317
2284 x 2186	7672	-	-	-	1907	-	-
2439 x 1931	8064	-	-	-	1901	-	2423
2439 x 1981	8066	-	-	-	1901	-	2423
2439 x 2031	8068	-	-	-	2008	-	-
2439 x 2136	8070	-	-	-	1943	-	2443
2439 x 2186	8072	-	-	-	2052	-	-
2590 x 1981	8666	-	-	-	2010	-	-
2590 x 2136	8670	-	-	-	2069	-	-
2744 x 1981	9066	-	-	-	2111	-	-
2744 x 2136	9070	-	-	-	2194	-	-

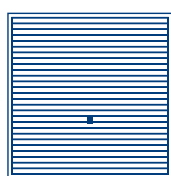
**Single door -
purpose-made sizes**Nominal Door Size
Width x Height
(mm x mm)

Horizon

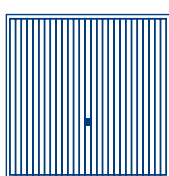

Carlton

		Horizon		Carlton	
		C	R	C	R
1985-2134	x 1830-1930	1819	1868	1864	1913
1985-2134	x 1931-1981	1891	1940	1940	1989
1985-2134	x 1982-2136	1997	2046	2022	2071
2135-2284	x 1830-1930	1891	1940	1919	1968
2135-2284	x 1931-1981	1997	2046	1997	2046
2135-2284	x 1982-2136	2079	2128	2127	2176
2285-2499	x 1830-1930	-	-	-	2073
2285-2499	x 1931-1981	-	-	-	2158
2285-2499	x 1982-2136	-	-	-	2238
2500-2590	x 1830-1930	-	-	-	2184
2500-2590	x 1931-1981	-	-	-	2251
2500-2590	x 1982-2136	-	-	-	2327
2591-2722	x 1830-1930	-	-	-	2249
2591-2722	x 1931-1981	-	-	-	2315
2591-2722	x 1982-2136	-	-	-	2434

Orders for purpose made sizes will only be accepted as overall frame size when ordering a framed version. Orders for purpose made framed doors will not be accepted as nominal door size.

Options for single doors

add

For powder coated doors: Moss Green (RAL 6005), Ruby Red (RAL 3003), Signal Blue (RAL 5005), Jet Black (RAL 9005), Steel Blue (RAL 5011), Light Ivory (RAL 1015), Pigeon Blue (RAL 5014), Fir Green (RAL 6009), Anthracite Grey (RAL 7016), Stone Grey (RAL 7030), Light Grey (RAL 7035), Slate Grey (RAL 7015), Agate Grey (RAL 7038), Window Grey (RAL 7040), Chartwell Green (BS 4800), Burgundy Brown², Golden Brown² and Terra Brown (RAL 8028).

176

Coloured window frames on Salisbury to match door colour¹

221

Poly-wrapping

47

¹ Colour match windows not available in Burgundy Brown or Golden Brown.



Secured by Design is an association focusing on the design of more secure homes and commercial properties.

Secured by Design is owned by the ACPO (Association of Chief Police Officers) and awards the Secured by Design status to products that pass their extensive testing procedures.

Design Range

Surface and finish

The Series 100 Design Range skins are built from four horizontal skins, whilst the Series 200 range is constructed from three vertical skins. Stainless steel elements on Garador design range doors are manufactured from high grade 2 mm thick steel with a brushed finish. The series 100 and 200 design range doors are also available without stainless steel elements. On Design Range doors a choice of any standard colour comes free of charge, please see page 19 for a choice of the 19 standard RAL colours available.

Please note: panel doors are produced with appearance in mind. This may result in some small gaps which could allow water ingress especially in exposed locations.

Handle

A new perfectly matched handle offers a quality feel everytime you open the door.

Terminology



Nominal Door Size: This is the actual door panel size plus the fitting tolerances. The nominal door size should be used for internal dimensions of a timber frame.

Size Code: This has traditionally been used to order doors. This may not be the actual door size.

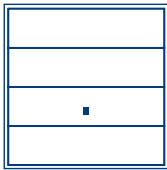
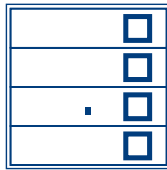
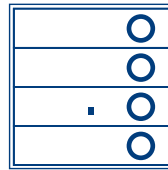
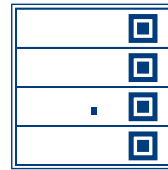
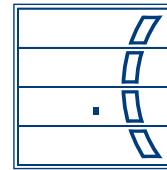
Single door

Nominal Door Size Width x Height (mm x mm)	Size Code										
		C	R	C	R	C	R	C	R	C	R
2134 x 1981	7066	1355	1404	1624	1673	1624	1673	1624	1673	1624	1673
2134 x 2136	7070	1444	1493	1713	1762	1713	1762	1713	1762	1713	1762
2259 x 1981	7566	1491	1540	1758	1807	1758	1807	1758	1807	1758	1807
2259 x 2136	7570	1578	1627	1850	1899	1850	1899	1850	1899	1850	1899
2284 x 1981	7666	1518	1567	1784	1833	1784	1833	1784	1833	1784	1833
2284 x 2136	7670	1606	1655	1875	1924	1875	1924	1875	1924	1875	1924
2439 x 1981	8066	1713	1762	1981	2030	1981	2030	1981	2030	1981	2030
2439 x 2136	8070	1802	1851	2072	2121	2072	2121	2072	2121	2072	2121

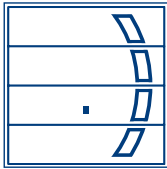
Single door

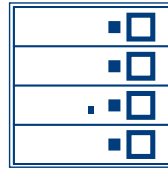
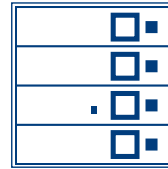
Nominal Door Size Width x Height (mm x mm)	Size Code								
		C	R	C	R	C	R	C	R
2134 x 1981	7066	1624	1673	1624	1673	1624	1673	1624	1673
2134 x 2136	7070	1713	1762	1713	1762	1713	1762	1713	1762
2259 x 1981	7566	1758	1807	1758	1807	1758	1807	1758	1807
2259 x 2136	7570	1850	1899	1850	1899	1850	1899	1850	1899
2284 x 1981	7666	1784	1833	1784	1833	1784	1833	1784	1833
2284 x 2136	7670	1875	1924	1875	1924	1875	1924	1875	1924
2439 x 1981	8066	1981	2030	1981	2030	1981	2030	1981	2030
2439 x 2136	8070	2072	2121	2072	2121	2072	2121	2072	2121

Single door

Nominal Door Size
Width x Height
(mm x mm)

Size
Code

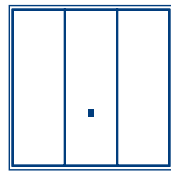

200

C

R

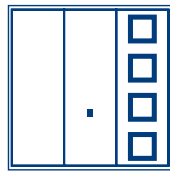

201

C

R

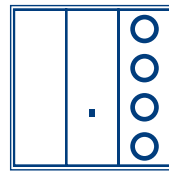

202

C

R

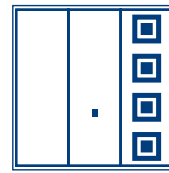

203

C

R

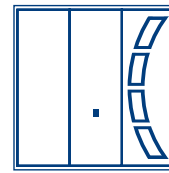

204

C

R

Nominal Door Size	Size Code	200 C	200 R	201 C	201 R	202 C	202 R	203 C	203 R	204 C	204 R
2134 x 1981	7066	1355	1404	1624	1673	1624	1673	1624	1673	1624	1673
2134 x 2136	7070	1444	1493	1713	1762	1713	1762	1713	1762	1713	1762
2259 x 1981	7566	1491	1540	1758	1807	1758	1807	1758	1807	1758	1807
2259 x 2136	7570	1578	1627	1850	1899	1850	1899	1850	1899	1850	1899
2284 x 1981	7666	1518	1567	1784	1833	1784	1833	1784	1833	1784	1833
2284 x 2136	7670	1606	1655	1875	1924	1875	1924	1875	1924	1875	1924
2439 x 1981	8066	1713	1762	1981	2030	1981	2030	1981	2030	1981	2030
2439 x 2136	8070	1802	1851	2072	2121	2072	2121	2072	2121	2072	2121

Single door

Nominal Door Size
Width x Height
(mm x mm)

Size
Code

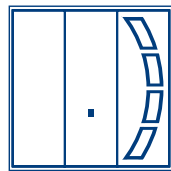

205

C

R

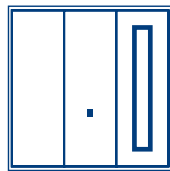

210

C

R

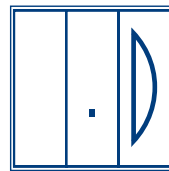

211

C

R

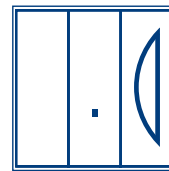

212

C

R

Nominal Door Size	Size Code	205 C	205 R	210 C	210 R	211 C	211 R	212 C	212 R
2134 x 1981	7066	1624	1673	1624	1673	1624	1673	1624	1673
2134 x 2136	7070	1713	1762	1713	1762	1713	1762	1713	1762
2259 x 1981	7566	1758	1807	1758	1807	1758	1807	1758	1807
2259 x 2136	7570	1850	1899	1850	1899	1850	1899	1850	1899
2284 x 1981	7666	1784	1833	1784	1833	1784	1833	1784	1833
2284 x 2136	7670	1875	1924	1875	1924	1875	1924	1875	1924
2439 x 1981	8066	1981	2030	1981	2030	1981	2030	1981	2030
2439 x 2136	8070	2072	2121	2072	2121	2072	2121	2072	2121

Options for single doors

add

Factory pre-fitted steel frame

178

Additional Lock Kit, C-type/ R-type (fitted onto door)

83

Retractable plus gear

85

Poly-wrapping

47

Please specify on order if you would like the design elements on the right or the left hand side of the door panel (viewed from outside).

Colour options on Design Range doors are free of charge. Available options are: White (RAL 9016), Terra Brown (RAL 8028), Moss Green (RAL 6005), Ruby Red (RAL 3003), Signal Blue (RAL 5005), Jet Black (RAL 9005), Steel Blue (RAL 5011), Light Ivory (RAL 1015), Pigeon Blue (RAL 5014), Fir Green (RAL 6009), Anthracite Grey (RAL 7016), Stone Grey (RAL 7030), Light Grey (RAL 7035), Slate Grey (RAL 7015), Agate Grey (RAL 7038), Window Grey (RAL 7040), Chartwell Green (BS 4800), Burgundy Brown and Golden Brown (solid).

GRP Premier Panel Doors

Surface

High gloss or woodgrain finish depending on door style.

GRP Premier doors are constructed as an infill panel and are fixed into a rigid box section chassis.

The infill has a flow coat to the inside face for a smoother finish and reduced translucency.

Please note: panel doors are produced with appearance in mind. This may result in some small gaps which could allow water ingress especially in exposed locations.

Standard colours

Arden and Stamford are available in Gloss White and Gloss Magnolia finish only. All other doors are available in the following range of woodgrain colours: White, Magnolia, Bleached Oak, Red Mahogany, Dark Mahogany, Light Oak, Dark Oak, Irish Oak, Honey Beech, Teak, Golden Brown, Ebony and Anthracite Grey.

Due to the production processes door colours may vary. Should you require matching doors please specify on your order.

Please note when trying to colour match garage doors with other UPVC products always check a colour sample first. The gel coats used in the process will not necessarily be a match and we will not guarantee a match with any other product.

Premium colours

Our GRP premium colour range includes Blue and Green. There is an additional surcharge for these colours, see page 24 for details.

Chassis colour

Traffic White (RAL 9016) for White Woodgrain and Gloss White doors, Black (RAL 9005) for Ebony coloured doors, Anthracite Grey (RAL 7016) for Anthracite Grey doors, Light Ivory (RAL 1015) for Magnolia Gloss and Magnolia doors, Fir Green (RAL 6009) for Green doors and Steel Blue (RAL 5011) for Blue doors.

Burgundy Brown will be used as the chassis colour for Red Mahogany, Dark Oak and Dark Mahogany.

All other doors will be supplied with a Terra Brown (RAL 8028) chassis.

Handle

Black handle and base plate as standard, optional handles available. Doors can be supplied undrilled and without handle and locking mechanism for use with electric operator. This must be requested at the time of order.

Certain panel configurations may only be available without handle or locking, therefore only suitable for electric operation (consult Garador sales office for exact details).

Terminology

Nominal Door Size: This is the actual door panel size plus the fitting tolerances. The nominal door size should be used for internal dimensions of a timber frame.

Size Code: This has traditionally been used to order doors. This may not be the actual door size.

Packaging

Supplied with front surface protection as standard.

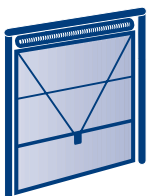

Canopy gearing (shown as C)

Canopy gear is available for all single doors providing a reliable and affordable gearing solution, with no tracks running back into the garage.

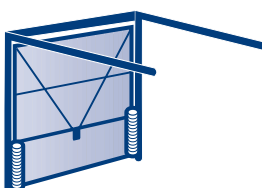

Retractable gearing (shown as R)

Retractable gear is available for all single and double doors providing a reliable and affordable gearing solution, with tracks running back into the garage.

Single door

Nominal Door Size
Width x Height
(mm x mm)

Size
Code

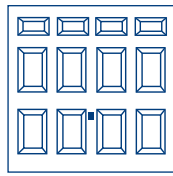

Arden

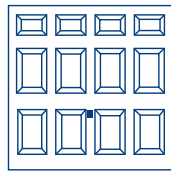

Kenmore

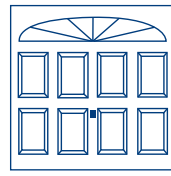

Stamford

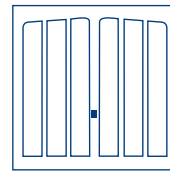

Penshurst

Nominal Door Size Width x Height (mm x mm)	Size Code	Arden		Kenmore		Stamford		Penshurst	
		C	R	C	R	C	R	C	R
2134 x 1981	7066	2712	2761	2767	2816	2847	2896	2935	2984
2134 x 2136	7070	2712	2761	2767	2816	2847	2896	2935	2984
2259 x 1981	7566	2837	2886	2910	2959	2961	3010	3163	3212
2259 x 2136	7570	2837	2886	2910	2959	2961	3010	3163	3212
2284 x 1981	7666	2859	2908	2935	2984	2994	3043	3193	3242
2284 x 2136	7670	2859	2908	2935	2984	2994	3043	3193	3242
2439 x 1981	8066	3123	3172	3156	3205	3241	3290	3398	3447
2439 x 2136	8070	3123	3172	3156	3205	3241	3290	3398	3447
2744 x 1981	9066	-	3480 ¹	-	3563 ¹	-	-	-	-
2744 x 2136	9070	-	3480 ¹	-	3563 ¹	-	-	-	-
3049 x 1981	1066	-	3820 ¹	-	3942 ¹	-	-	-	-
3049 x 2136	1070	-	3820 ¹	-	3942 ¹	-	-	-	-

¹ Doors only available with electric operation (Handle and Locking not available).

Single door

Nominal Door Size
Width x Height
(mm x mm)

Size
Code

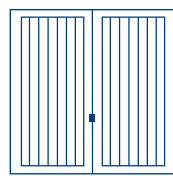

Swinton

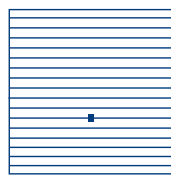

Glastonbury

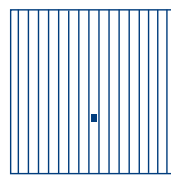

Somerset

Nominal Door Size Width x Height (mm x mm)	Size Code	Swinton		Glastonbury		Somerset	
		C	R	C	R	C	R
2134 x 1981	7066	2935	2984	2935	2984	2935	2984
2134 x 2136	7070	2935	2984	2935	2984	2935	2984
2259 x 1981	7566	3163	3212	3163	3212	3163	3212
2259 x 2136	7570	3163	3212	3163	3212	3163	3212
2284 x 1981	7666	3193	3242	3193	3242	3193	3242
2284 x 2136	7670	3193	3242	3193	3242	3193	3242
2439 x 1981	8066	3398	3447	-	-	3398	3447
2439 x 2136	8070	3398	3447	-	-	3398	3447
2744 x 1981	9066	-	-	-	-	-	3807
2744 x 2136	9070	-	-	-	-	-	3807
3049 x 1981	1066	-	-	-	-	-	4180
3049 x 2136	1070	-	-	-	-	-	4180

Please note that doors with windows may have cross bracing or locking rods passing behind the windows depending upon size and gear type.

For further options please see page 24.

Single door

Nominal Door Size
Width x Height
(mm x mm)

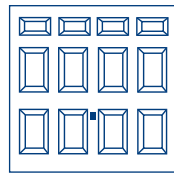

Arden

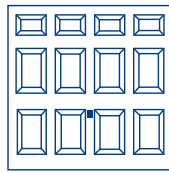

Kenmore

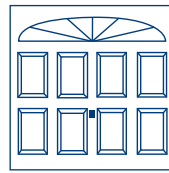

Stamford

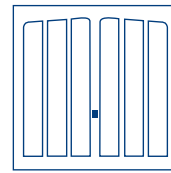

Penshurst

Nominal Door Size Width x Height (mm x mm)	Arden		Kenmore		Stamford		Penshurst	
	C	R	C	R	C	R	C	R
2032-2133 x 1931-1980	-	-	-	-	-	-	3241	3290
2032-2133 x 1981-2136	-	-	-	-	-	-	3241	3290
2032-2133 x 2137-2286	-	-	-	-	-	-	-	3744
2134-2439 x 1931-1980	-	-	-	-	-	-	3720	3769
2134-2439 x 1981-2136	3420	3469	3459	3508	3557	3606	3720	3769
2134-2439 x 2137-2286	-	3944	-	3992	-	-	-	4303
2440-2590 x 1931-1980	-	-	-	-	-	-	-	-
2440-2590 x 1981-2136	-	-	-	-	-	-	-	-
2440-2590 x 2137-2286	-	-	-	-	-	-	-	-
2591-2744 x 1931-1980	-	-	-	-	-	-	-	-
2591-2744 x 1981-2136	-	-	-	3983 ¹	-	-	-	-
2591-2744 x 2137-2286	-	-	-	-	-	-	-	-
2745-2896 x 1931-1980	-	-	-	-	-	-	-	-
2745-2896 x 1981-2136	-	4238 ¹	-	4353 ¹	-	-	-	-
2745-2896 x 2137-2286	-	-	-	-	-	-	-	-
2897-3049 x 1931-1980	-	-	-	-	-	-	-	-
2897-3049 x 1981-2136	-	4238 ¹	-	4353 ¹	-	-	-	-
2897-3049 x 2137-2286	-	-	-	-	-	-	-	-

¹ Doors only available with electric operation (Handle and Locking not available).

Single door

Nominal Door Size
Width x Height
(mm x mm)

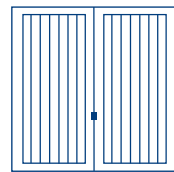

Swinton

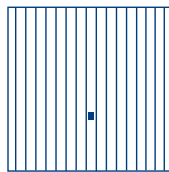

Somerset

Nominal Door Size Width x Height (mm x mm)	Swinton		Somerset	
	C	R	C	R
2259-2439 x 1981-2136	3720	3769	3720	3769
2259-2439 x 2150-2286	-	4027	-	3775
2440-2590 x 1931-1980	-	-	-	3831
2440-2590 x 1981-2136	-	-	-	3831
2440-2590 x 2137-2286	-	-	-	3831
2591-2744 x 1931-1980	-	-	-	4058
2591-2744 x 1981-2136	-	-	-	4058
2591-2744 x 2137-2286	-	-	-	4058
2745-2896 x 1931-1980	-	-	-	4378
2745-2896 x 1981-2136	-	-	-	4378
2745-2896 x 2137-2286	-	-	-	4378
2897-3049 x 1931-1980	-	-	-	4636
2897-3049 x 1981-2136	-	-	-	4636
2897-3049 x 2137-2286	-	-	-	4636

Orders for purpose made sizes will only be accepted as nominal door size for unframed version and overall frame size when ordering a framed version. Orders for purpose made framed doors will not be accepted as nominal door size. Please note that doors with windows may have cross bracing or locking rods passing behind the windows depending upon size and gear type. For further options please see page 24.

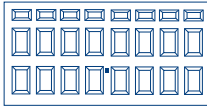
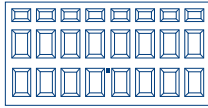
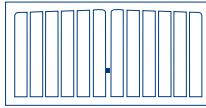
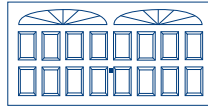
Double door					
Nominal Door Size Width x Height (mm x mm)	Size Code	Arden R	Kenmore R	Penshurst R	Stamford R
3354 x 1981	1166	3820	3973	-	-
3354 x 2136	1170	3820	3973	-	-
3354 x 2286	1176	3820	-	-	-
3659 x 1981	1266	4135 ¹	4316 ¹	-	-
3659 x 2136	1270	4135 ¹	4316 ¹	-	-
3659 x 2286	1276	4135	-	-	-
3964 x 1981	1366	4442 ¹	4661 ¹	-	-
3964 x 2136	1370	4442 ¹	4661 ¹	-	-
3964 x 2286	1376	4442	-	-	-
4269 x 1981	1466	4750	5018	5228	5247 ¹
4269 x 2136	1470	4750	5018	5228	5247 ¹
4269 x 2286	1476	4750	-	-	-

¹ Doors only available with electric operation (Handle and Locking not available).

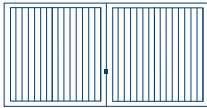
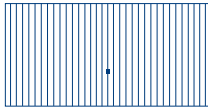
Double door			
Nominal Door Size Width x Height (mm x mm)	Size Code	Swinton R	Somerset R
3354 x 1981	1166	-	3973
3354 x 2136	1170	-	3973
3354 x 2286	1176	-	-
3659 x 1981	1266	-	4316
3659 x 2136	1270	-	4316
3659 x 2286	1276	-	-
3964 x 1981	1366	-	4661
3964 x 2136	1370	-	4661
3964 x 2286	1376	-	-
4269 x 1981	1466	-	5094
4269 x 2136	1470	5247	5094
4269 x 2286	1476	-	-

¹ Doors only available with electric operation (Handle and Locking not available).

Please note that doors with windows may have cross bracing or locking rods passing behind the windows depending upon size and gear type.

For further options please see page 24.

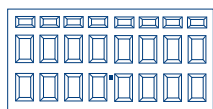
Double doorNominal Door Size
Width x Height
(mm x mm)

Arden

R

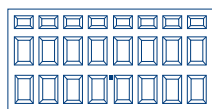

Kenmore

R

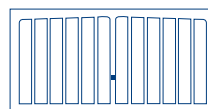

Penshurst

R

3050-3355	x	1981-2136	4081	4246	-
3050-3355	x	2137-2286	4230	-	-
3356-3660	x	1981-2136	4385 ¹	4591 ¹	-
3356-3660	x	2137-2286	4535	-	-
3661-3965	x	1981-2136	4693 ¹	4935 ¹	-
3661-3965	x	2137-2286	4844	-	-
3966-4117	x	1981-2136	4999 ¹	5266 ¹	-
3966-4117	x	2137-2286	4999	-	-
4118-4269	x	1981-2136	4999	5266	5484
4118-4269	x	2137-2286	5290	-	-

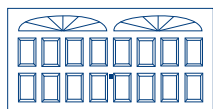
¹ Doors only available with electric operation (Handle and Locking not available).**Double door**Nominal Door Size
Width x Height
(mm x mm)

Stamford

R

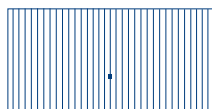

Somerset

R









3050-3355	x	1981-2136	-	4246
3050-3355	x	2137-2286	-	4246
3356-3660	x	1981-2136	-	4591
3356-3660	x	2137-2286	-	4591
3661-3965	x	1981-2136	-	4935
3661-3965	x	2137-2286	-	4935
3966-4117	x	1981-2136	-	5266
3966-4117	x	2137-2286	-	5266
4118-4269	x	1981-2136	5519 ¹	5484
4118-4269	x	2137-2286	-	5484

¹ Doors only available with electric operation (Handle and Locking not available).







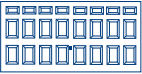

Orders for purpose made sizes will only be accepted as nominal door size for unframed version and overall frame size when ordering a framed version. Orders for purpose made framed doors will not be accepted as nominal door size.

Options

Options	Single doors add	Double doors add
Factory pre-framed standard single doors	178	-
Steel frame for standard double doors	-	267
Factory pre-framed purpose-made single doors	201	-
Steel frame for purpose-made double doors	-	297
Additional Lock Kit, C-type/ R-type (fitted onto door)	83	-
Retractable plus gear available on 1931, 1981 and 2136 mm high doors up to 2744 mm wide	85	-
Diecast metal handles with matching base plates: brass effect, brushed steel, chrome effect and white	124	124
Surcharge for Premium colours Green and Blue	407	809
Surcharge for steel frame in colour not matching garage door	176	275
Surcharge for colour steel frame on Matt or Gloss White Garage door	176	275

GRP Window options for standard and purpose-made single doors				Additional Cost (Width mm)	
	Stamford	Arden	Kenmore	up to 2743	2744-3049
 Clear Perspex	X	X	X	221	327
 Stippled Perspex	X	X	X	222	327
 Stippled Perspex with diamond leading	-	X	X	363	533
 Stippled Perspex with square leading	-	X	X	363	533
 Black Non-Translucent	X	X	X	222	327
 Black Non-Translucent Perspex with border and diamond leading	-	X	X	363	533

Please state window code on order.

GRP Window options for standard and purpose-made double doors				Additional Cost (Width mm)	
	Stamford	Arden	Kenmore	3354 - 3963	3964 - 4269
 Clear Perspex	X	X	X	383	436
 Stippled Perspex	X	X	X	383	436
 Stippled Perspex with diamond leading	-	X	X	624	748
 Stippled Perspex with square leading	-	X	X	624	748
 Black Non-Translucent	X	X	X	383	436
 Black Non-Translucent Perspex with border and diamond leading	-	X	X	624	748

Please state window code on order.

Please note that doors with windows may have cross bracing or locking rods passing behind the windows depending upon size and gear type.

Timber Panel Doors

Surface

Timber doors are supplied untreated and require immediate on-site finishing unless fully finished option specified. Timber is a natural material and therefore Garador cannot guarantee to be able to produce matching timber garage doors. Chassis colours will be Brown (RAL 8028) on all timber doors

Please note: panel doors are produced with appearance in mind. This may result in some small gaps which could allow water ingress especially in exposed locations.

Handle

Black handle and base plate supplied as standard, optional handles available. Doors can alternatively be supplied undrilled and without handle and locking mechanism for use with electric operator.

Packaging

Supplied wrapped with additional foam protection on surface of panel as standard.

Terminology

Nominal Door Size: This is the actual door panel size plus the fitting tolerances. The nominal door size should be used for internal dimensions of a timber frame.

Size Code: This has traditionally been used to order doors. This may not be the actual door size.

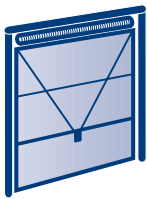

Canopy gearing (shown as C)

Canopy gear is available for all single doors providing a reliable and affordable gearing solution, with no tracks running back into the garage.

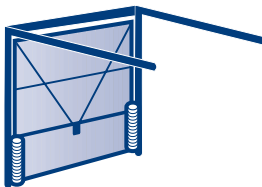

Retractable gearing (shown as R)

Retractable gear is available for all single and double doors providing a reliable and affordable gearing solution, with tracks running back into the garage.

Single door

Nominal Door Size
Width x Height
(mm x mm)

Size
Code

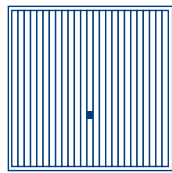

Vertical Timber

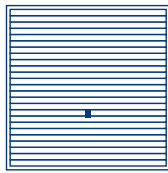

Horizontal Timber

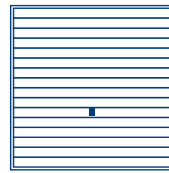

Countryman

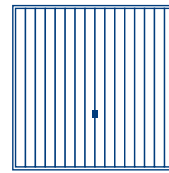

Hampton

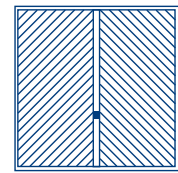

Chevron Timber

Nominal Door Size Width x Height (mm x mm)	Size Code	Vertical Timber		Horizontal Timber		Countryman		Hampton		Chevron Timber	
		C	R	C	R	C	R	C	R	C	R
2134 x 1981	7066	2814	2863	2961	3010	3514	3563	3514	3563	4184	4233
2134 x 2136	7070	2842	2891	2987	3036	3543	3592	3543	3592	4251	4300
2134 x 2286	7076	-	3216	-	3378	-	3984	-	3984	-	4487
2259 x 1981	7566	2961	3010	3115	3164	3696	3745	3696	3745	4464	4513
2259 x 2136	7570	2988	3037	3145	3194	3728	3777	3728	3777	4485	4534
2284 x 1981	7666	2961	3010	3413	3462	3696	3745	3696	3745	4464	4513
2284 x 2136	7670	2988	3037	3145	3194	3728	3777	3728	3777	4485	4534
2284 x 2286	7676	-	3335	-	3508	-	3997	-	3997	-	4706
2439 x 1981	8066	3134	3183	3299	3348	3907	3956	3907	3956	4611	4660
2439 x 2136	8070	3157	3206	3323	3372	3938	3987	3938	3987	4637	4686
2439 x 2286	8076	-	3539	-	3712	-	4235	-	4235	-	4832
2744 x 1981	9066	-	3693	-	3881	-	4409	-	4409	-	5142
2744 x 2136	9070	-	3718	-	3903	-	4457	-	4457	-	5215
2744 x 2286	9076	-	4056	-	4266	-	4771	-	4771	-	5390
3049 x 1981	1066	-	4275	-	4485	-	4980	-	4980	-	5772
3049 x 2136	1070	-	4314	-	4534	-	5021	-	5021	-	5818

Single door

Nominal Door Size
Width x Height
(mm x mm)

Size
Code

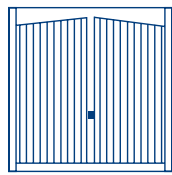

Barrington

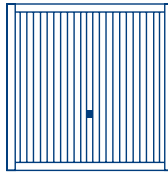

Kingsbury

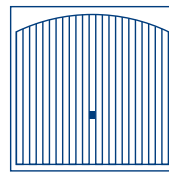

Adlington



Ashton¹

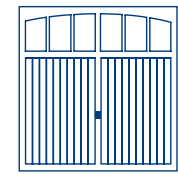

Rochdale¹

Nominal Door Size Width x Height (mm x mm)	Size Code	Barrington		Kingsbury		Adlington		Ashton ¹		Rochdale ¹	
		C	R	C	R	C	R	C	R	C	R
2134 x 1981	7066	3573	3622	3543	3592	3220	3269	4184	4233	4228	4277
2134 x 2136	7070	3596	3645	3571	3620	3220	3269	4251	4300	4257	4306
2134 x 2286	7076	-	3983	-	3948	-	3559	-	4487	-	4541
2259 x 1981	7566	3715	3764	3684	3733	3360	3409	4464	4513	4383	4432
2259 x 2136	7570	3738	3787	3712	3761	3381	3430	4485	4534	4404	4453
2284 x 1981	7666	3715	3764	3684	3733	3360	3409	4464	4513	4383	4432
2284 x 2136	7670	3738	3787	3712	3761	3381	3430	4485	4534	4404	4453
2284 x 2286	7676	-	4115	-	4085	-	3718	-	4706	-	4627
2439 x 1981	8066	3845	3894	3812	3861	3696	3745	4611	4660	4522	4571
2439 x 2136	8070	3870	3919	3840	3889	3696	3745	4637	4686	4559	4608
2439 x 2286	8076	-	4235	-	4199	-	3787	-	4832	-	4742
2744 x 1981	9066	-	4386	-	4239	-	3939	-	5142	-	5174
2744 x 2136	9070	-	4425	-	4275	-	3939	-	5215	-	5257
2744 x 2286	9076	-	4769	-	4627	-	4251	-	5390	-	5423
3049 x 1981	1066	-	4960	-	4814	-	4258	-	5772	-	5815
3049 x 2136	1070	-	5001	-	4853	-	4258	-	5818	-	5856

¹ Ashton and Rochdale doors may have cross bracing and / or locking rods behind the windows depending upon the size and gear type.

For further options please see page 35.

Single door

Nominal Door Size
Width x Height
(mm x mm)

Size
Code

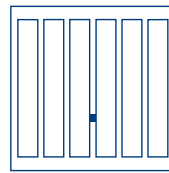
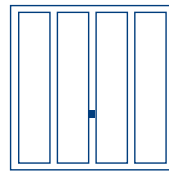
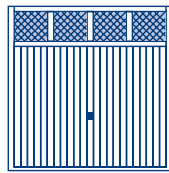

Sandhurst¹

Shaftesbury

Grantham

Seymour

C

R

C

R

C

R

C

R

Nominal Door Size Width x Height (mm x mm)	Size Code	C	R	C	R	C	R	C	R
2134 x 1981	7066	4099	4148	3176	3225	2139	2188	3033	3082
2134 x 2136	7070	4124	4173	3194	3243	2139	2188	3062	3111
2134 x 2286	7076	-	4404	-	3436	-	2358	-	3293
2259 x 1981	7566	4250	4299	3237	3286	2277	2326	3099	3148
2259 x 2136	7570	4275	4324	3259	3308	2277	2326	3123	3172
2284 x 1981	7666	4250	4299	3237	3286	2277	2326	3099	3148
2284 x 2136	7670	4275	4324	3259	3308	2277	2326	3123	3172
2284 x 2286	7676	-	4495	-	3480	-	2520	-	3342
2439 x 1981	8066	4391	4440	3291	3340	2364	2413	3151	3200
2439 x 2136	8070	4426	4475	3319	3368	2364	2413	3176	3225
2439 x 2286	8076	-	4610	-	3511	-	2620	-	3371
2744 x 1981	9066	-	4975	-	3983	-	2684	-	3813
2744 x 2136	9070	-	5057	-	4016	-	2684	-	3840
2744 x 2286	9076	-	5227	-	4202	-	2869	-	4000
3049 x 1981	1066	-	5614	-	4478	-	2916	-	4297
3049 x 2136	1070	-	5655	-	4520	-	2916	-	4300

¹ Sandhurst doors may have cross bracing and/or locking rods behind the windows depending upon the size and gear type.

Single door

Nominal Door Size
Width x Height
(mm x mm)

Size
Code

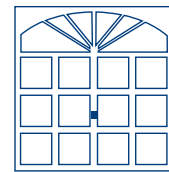
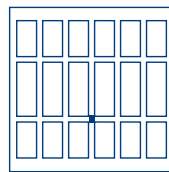
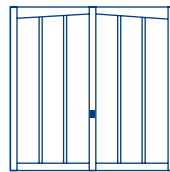
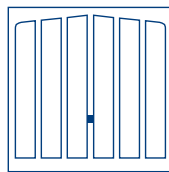

Tudor

Bosworth

Wolsley

Hinton²

C

R

C

R

C

R

C

R

Nominal Door Size Width x Height (mm x mm)	Size Code	C	R	C	R	C	R	C	R
2134 x 1981	7066	3176	3225	3217	3266	3173	3222	4400	4449
2134 x 2136	7070	3194	3243	3238	3287	3192	3241	4427	4476
2134 x 2286	7076	-	3436	-	3477	-	3432	-	4666
2259 x 1981	7566	3237	3286	3281	3330	3234	3283	4675	4724
2259 x 2136	7570	3259	3308	3305	3354	3255	3304	4701	4750
2284 x 1981	7666	3237	3286	3281	3330	3234	3283	4675	4724
2284 x 2136	7670	3259	3308	3305	3354	3255	3304	4701	4750
2284 x 2286	7676	-	3480	-	3527	-	3478	-	4916
2439 x 1981	8066	3291	3340	3333	3382	3288	3337	4813	4862
2439 x 2136	8070	3319	3368	3354	3403	3310	3359	4843	4892
2439 x 2286	8076	-	3511	-	3555	-	3509	-	5033
2744 x 1981	9066	-	3983	-	4025	-	3884	-	5435
2744 x 2136	9070	-	4016	-	4052	-	3914	-	5465
2744 x 2286	9076	-	4202	-	4241	-	4073	-	5646
3049 x 1981	1066	-	4478	-	4520	-	4339	-	6141
3049 x 2136	1070	-	4520	-	4559	-	4343	-	6177

² Hinton doors may have cross bracing and/or locking rods behind the windows depending upon the size and gear type.

For further options please see page 35.

Single door

Nominal Door Size
Width x Height
(mm x mm)

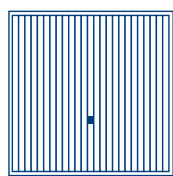

Vertical Timber

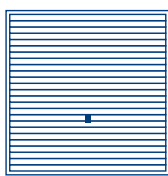

Horizontal Timber

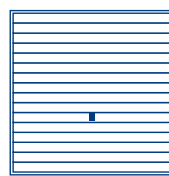

Countryman

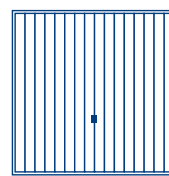

Hampton

		Vertical Timber		Horizontal Timber		Countryman		Hampton	
		C	R	C	R	C	R	C	R
1930-1984	x 1931-1981	3063	3112	3219	3268	4286	4335	4286	4335
1930-1984	x 1982-2136	3082	3131	3243	3292	4409	4458	4409	4458
1930-1984	x 2137-2286	-	3454	-	3628	-	4776	-	4776
1930-1984	x 2287-2439	-	3539	-	3712	-	5122	-	5122
1985-2284	x 1931-1981	3202	3251	3369	3418	4516	4565	4516	4565
1985-2284	x 1982-2136	3228	3277	3395	3444	4658	4707	4658	4707
1985-2284	x 2137-2286	-	3573	-	3749	-	5016	-	5016
1985-2284	x 2287-2439	-	3657	-	3837	-	5428	-	5428
2285-2439	x 1931-1981	3371 ¹	3420	3549 ¹	3598	4581 ¹	4630	4581 ¹	4630
2285-2439	x 1982-2136	3395 ¹	3444	3573 ¹	3622	4718 ¹	4767	4718 ¹	4767
2285-2439	x 2137-2286	-	3769	-	-	-	-	-	-
2285-2439	x 2287-2439	-	3914	-	-	-	-	-	-
2440-2744	x 1931-1981	-	3922	-	-	-	-	-	-
2440-2744	x 1982-2136	-	3948	-	-	-	-	-	-
2440-2744	x 2137-2286	-	4282	-	-	-	-	-	-
2440-2744	x 2287-2439	-	4400	-	-	-	-	-	-
2745-3049	x 1931-1981	-	4490	-	-	-	-	-	-
2745-3049	x 1982-2136	-	4536	-	-	-	-	-	-

¹ These doors are not available over 2438 mm wide.

Single door

Nominal Door Size
Width x Height
(mm x mm)

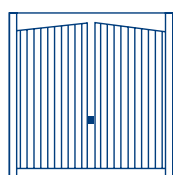

Barrington

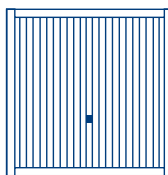

Kingsbury

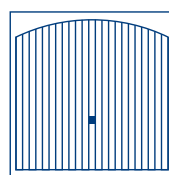

Adlington



Ashton²

		Barrington		Kingsbury		Adlington		Ashton ²	
		C	R	C	R	C	R	C	R
1930-1984	x 1931-1981	3873	3922	3846	3895	3305	3354	4498	4547
1930-1984	x 1982-2136	3896	3945	3872	3921	3328	3377	4522	4571
1930-1984	x 2137-2286	-	4286	-	4250	-	3696	-	4902
1930-1984	x 2287-2439	-	4366	-	4343	-	3779	-	4995
1985-2284	x 1931-1981	4012	4061	3988	4037	3449	3498	4641	4690
1985-2284	x 1982-2136	4040	4089	4009	4058	3473	3522	4663	4712
1985-2284	x 2137-2286	-	4423	-	4386	-	3819	-	5038
1985-2284	x 2287-2439	-	4500	-	4478	-	3897	-	5130
2285-2439	x 1931-1981	4143 ¹	4192	4112 ¹	4161	3616 ¹	3665	4766	4815
2285-2439	x 1982-2136	4166 ¹	4215	4140 ¹	4189	3640 ¹	3689	4794	4843
2285-2439	x 2137-2286	-	4538	-	4499	-	4016	-	5154
2285-2439	x 2287-2439	-	4651	-	4627	-	4156	-	5280
2440-2744	x 1931-1981	-	4689	-	4543	-	4168	-	5196
2440-2744	x 1982-2136	-	4722	-	4577	-	4187	-	5227
2440-2744	x 2137-2286	-	5078	-	4931	-	4529	-	5582
2440-2744	x 2287-2439	-	5190	-	5045	-	4643	-	5697
2745-3049	x 1931-1981	-	5262	-	5115	-	4736	-	5768
2745-3049	x 1982-2136	-	5307	-	5156	-	4776	-	5807

¹ These doors are not available over 2438 mm wide.

² Ashton doors may have cross bracing and / or locking rods behind the windows depending upon the size and gear type.

Orders for purpose made sizes will only be accepted as nominal door size for unframed version and overall frame size when ordering a framed version. Orders for purpose made framed doors will not be accepted as nominal door size. For further options please see page 35.

Single door

Nominal Door Size
Width x Height
(mm x mm)

Shaftesbury

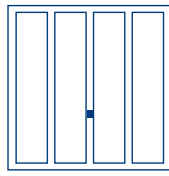

Grantham

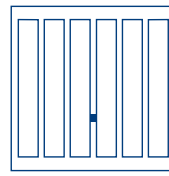

Seymour

		Shaftesbury		Grantham		Seymour	
		C	R	C	R	C	R
1930-1984	x 1931-1981	3334	3383	2799	2848	3334	3383
1930-1984	x 1982-2136	3360	3409	2824	2873	3360	3409
1930-1984	x 2137-2286	-	3596	-	3064	-	3596
1930-1984	x 2287-2439	-	3709	-	3174	-	3709
1985-2284	x 1931-1981	3397	3446	2865	2914	3397	3446
1985-2284	x 1982-2136	3426	3475	2892	2941	3426	3475
1985-2284	x 2137-2286	-	3645	-	3114	-	3645
1985-2284	x 2287-2439	-	3753	-	3221	-	3753
2285-2439	x 1931-1981	3454 ¹	3503	2922 ¹	2971	3454 ¹	3503
2285-2439	x 1982-2136	3477 ¹	3526	2942 ¹	2991	3477 ¹	3526
2285-2439	x 2137-2286	-	3674	-	3140	-	3674
2285-2439	x 2287-2439	-	3832	-	3295	-	3832
2440-2744	x 1931-1981	-	4112	-	3579	-	4112
2440-2744	x 1982-2136	-	4143	-	3611	-	4143
2440-2744	x 2137-2286	-	4301	-	3769	-	4301
2440-2744	x 2287-2439	-	4423	-	3885	-	4423
2745-3049	x 1931-1981	-	4601	-	4068	-	4601
2745-3049	x 1982-2136	-	4602	-	4069	-	4602

¹ These doors are not available over 2438 mm wide.

Single door

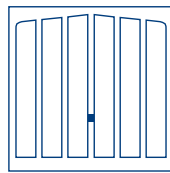
Nominal Door Size
Width x Height
(mm x mm)

Tudor

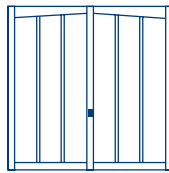

Bosworth

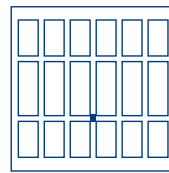

Wolsey

		Tudor		Bosworth		Wolsey	
		C	R	C	R	C	R
1930-1984	x 1931-1981	3477	3526	3516	3565	3471	3520
1930-1984	x 1982-2136	3497	3546	3542	3591	3494	3543
1930-1984	x 2137-2286	-	3735	-	3778	-	3730
1930-1984	x 2287-2439	-	3846	-	3891	-	3853
1985-2284	x 1931-1981	3541	3590	3582	3631	3537	3586
1985-2284	x 1982-2136	3567	3616	3605	3654	3559	3608
1985-2284	x 2137-2286	-	3785	-	3830	-	3779
1985-2284	x 2287-2439	-	3896	-	3939	-	3905
2285-2439	x 1931-1981	3594 ¹	3643	3632 ¹	3681	3588 ¹	3637
2285-2439	x 1982-2136	3616 ¹	3665	3658 ¹	3707	3614 ¹	3663
2285-2439	x 2137-2286	-	3815	-	3851	-	3812
2285-2439	x 2287-2439	-	4029	-	4069	-	3981
2440-2744	x 1931-1981	-	4286	-	4324	-	4184
2440-2744	x 1982-2136	-	4314	-	4358	-	4215
2440-2744	x 2137-2286	-	4500	-	4546	-	4374
2440-2744	x 2287-2439	-	4618	-	4661	-	4490
2745-3049	x 1931-1981	-	4781	-	4824	-	4643
2745-3049	x 1982-2136	-	4824	-	4863	-	4646

¹ These doors are not available over 2438 mm wide.

Orders for purpose made sizes will only be accepted as nominal door size for unframed version and overall frame size when ordering a framed version. Orders for purpose made framed doors will not be accepted as nominal door size.

For further options please see page 35.

Double door

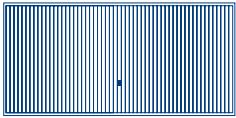
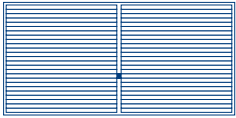
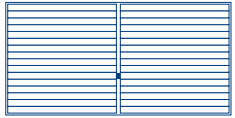
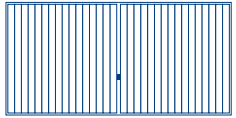
Nominal Door Size Width x Height (mm x mm)	Size Code				
		Vertical Timber	Horizontal Timber	Countryman	Hampton
		R	R	R	R
3049 x 2286	1076	4852	4915	6281	6281
3354 x 1981	1166	4852	4916	6218	6218
3354 x 2136	1170	4988	5056	6350	6350
3354 x 2286	1176	5394	5465	6886	6886
3659 x 1981	1266	5467	5542	6920	6920
3659 x 2136	1270	5609	5679	7054	7054
3659 x 2286	1276	6102	6182	7703	7703
3964 x 1981	1366	6463	6556	7625	7625
3964 x 2136	1370	6667	6759	7831	7831
3964 x 2286	1376	7235	7331	8515	8515
4269 x 1981	1466	6324	6417	7854	7854
4269 x 2136	1470	6463	6556	7989	7989
4574 x 1981	1566	7141	7240	-	-
4574 x 2136	1570	7345	7439	-	-
4879 x 1981	1666	7788	7892	-	-
4879 x 2136	1670	7855	7959	-	-

Double door

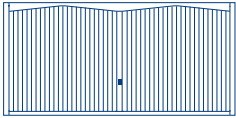
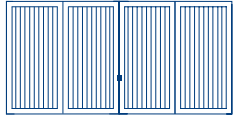
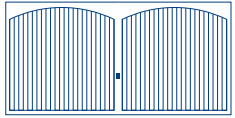
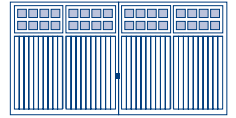
Nominal Door Size Width x Height (mm x mm)	Size Code				
		Barrington	Kingsbury	Adlington	Ashton ¹
		R	R	R	R
3049 x 2286	1076	5771	5504	5390	6412
3354 x 1981	1166	5728	5489	5287	6222
3354 x 2136	1170	5864	5625	5417	6357
3354 x 2286	1176	6357	6096	5871	6891
3659 x 1981	1266	6377	6135	5854	7146
3659 x 2136	1270	6514	6273	5987	7283
3659 x 2286	1276	7110	6876	6528	7956
3964 x 1981	1366	7420	7262	7086	8382
3964 x 2136	1370	7625	7465	7292	8588
3964 x 2286	1376	8288	8116	7925	9345
4269 x 1981	1466	7283	7127	6951	8247
4269 x 2136	1470	7420	7262	7086	8382
4574 x 1981	1566	8095	7992	-	9088
4574 x 2136	1570	8300	8196	-	9289
4879 x 1981	1666	8741	8641	-	9840
4879 x 2136	1670	8813	8710	-	9905

¹ Ashton doors may have cross bracing and/or locking rods behind the windows depending upon the size and gear type.

For further options please see page 35.

Double door

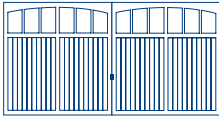
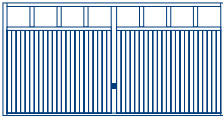
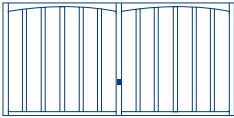
Nominal Door Size Width x Height (mm x mm)	Size Code			
		Rochdale ^{1,2}	Sandhurst ¹	Shaftesbury
		R	R	R
3049 x 2286	1076	6782	5962	4687
3354 x 1981	1166	6560	5923	4627
3354 x 2136	1170	6698	6059	4763
3354 x 2286	1176	7269	6572	5145
3659 x 1981	1266	7484	6682	5135
3659 x 2136	1270	7625	6819	5270
3659 x 2286	1276	8328	7439	5735
3964 x 1981	1366	8725	7799	5980
3964 x 2136	1370	8931	7999	6183
3964 x 2286	1376	9714	8704	6698
4269 x 1981	1466	8588	7658	5844
4269 x 2136	1470	8725	7799	5980
4574 x 1981	1566	9720	8710	6698
4574 x 2136	1570	9925	8917	6901
4879 x 1981	1666	10384	9663	7446
4879 x 2136	1670	10450	9735	7518

¹ Rochdale and Sandhurst doors may have cross bracing and/or locking rods behind the windows depending upon the size and gear type.

² Rochdale doors up to 3659 mm wide will be manufactured with one arch not the two as shown above.

Double door

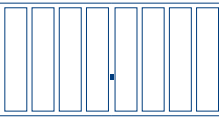
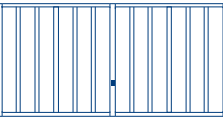
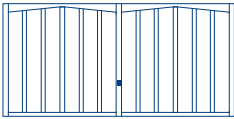
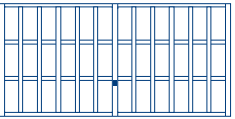
Nominal Door Size Width x Height (mm x mm)	Size Code				
		Grantham	Seymour	Tudor	Wolsey
		R	R	R	R
3049 x 2286	1076	4102	4640	4687	5262
3354 x 1981	1166	4017	4492	4627	5208
3354 x 2136	1170	4152	4627	4763	5345
3354 x 2286	1176	4474	4995	5145	5728
3659 x 1981	1266	4541	5069	5135	5716
3659 x 2136	1270	4678	5202	5270	5854
3659 x 2286	1276	5083	5665	5735	6313
3964 x 1981	1366	5083	5909	5980	6561
3964 x 2136	1370	5287	6115	6183	6766
3964 x 2286	1376	5707	6628	6698	7277
4269 x 1981	1466	4945	5771	5844	6425
4269 x 2136	1470	5083	5909	5980	6561
4574 x 1981	1566	-	-	6698	7277
4574 x 2136	1570	-	-	6901	7480
4879 x 1981	1666	-	-	7446	8030
4879 x 2136	1670	-	-	7518	8095

For further options please see page 35.

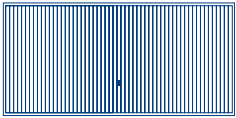
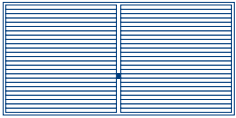
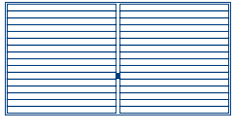
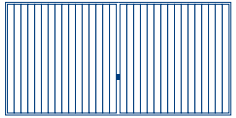

Double door

Nominal Door Size
Width x Height
(mm x mm)

				
	Vertical Timber	Horizontal Timber	Countryman	Hampton
	R	R	R	R
2745-3049 x 2137-2286	-	-	-	-
3050-3659 x 1931-1981	6014	6096	7382	7382
3050-3659 x 1982-2136	6164	6246	7529	7529
3050-3659 x 2137-2286	6710	6801	8225	8225
3660-4269 x 1931-1981	7331	7434	8744	8744
3660-4269 x 1982-2136	7562	7658	8968	8968
3660-4269 x 2137-2286	7937	8043	9417	9417
4270-5000 x 1931-1981	8568	8678	-	-
4270-5000 x 1982-2136	8641	8753	-	-

Double door

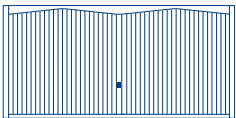
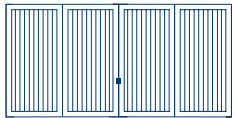
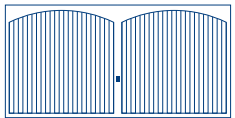
Nominal Door Size
Width x Height
(mm x mm)

				
	Barrington	Kingsbury	Adlington	Ashton ¹
	R	R	R	R
2745-3049 x 2137-2286	-	-	-	7045
3050-3659 x 1931-1981	7012	6752	6432	7858
3050-3659 x 1982-2136	7163	6901	6583	8009
3050-3659 x 2137-2286	7818	7562	7175	8744
3660-4269 x 1931-1981	8386	8218	8022	9445
3660-4269 x 1982-2136	8611	8440	8246	9668
3660-4269 x 2137-2286	9041	8858	8657	10151
4270-5000 x 1931-1981	9617	9506	-	10817
4270-5000 x 1982-2136	9696	9579	-	10892

¹ Ashton doors may have cross bracing and/or locking rods behind the windows depending upon the size and gear type.

Orders for purpose made sizes will only be accepted as nominal door size for unframed version and overall frame size when ordering a framed version. Orders for purpose made framed doors will not be accepted as nominal door size.

For further options please see page 35.

Double door

Nominal Door Size
Width x Height
(mm x mm)

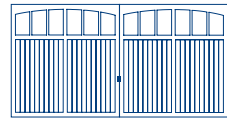

Rochdale^{1,2}

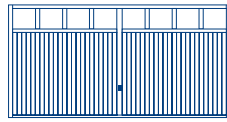

Sandhurst¹

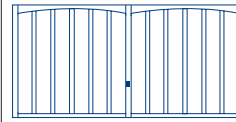

Shaftesbury

	R	R	R
2745-3049 x 2137-2286	7460	6556	5146
2745-3049 x 2287-2439	7838	6883	5409
3050-3659 x 1931-1981	8235	7351	5646
3050-3659 x 1982-2136	8386	7501	5796
3050-3659 x 2137-2286	9159	8183	6308
3050-3659 x 2287-2439	9612	8591	6622
3660-4269 x 1931-1981	9822	8800	6802
3660-4269 x 1982-2136	10046	9024	7029
3660-4269 x 2137-2286	10547	9473	7381
3660-4269 x 2287-2439	11049	9925	7728
4270-5000 x 1931-1981	11421	10632	8190
4270-5000 x 1982-2136	11494	10705	8267

¹ Rochdale and Sandhurst doors may have cross bracing and/or locking rods behind the windows depending upon the size and gear type.

² Rochdale doors up to 3659 mm wide will be manufactured with one arch not the two as shown above.

Double door

Nominal Door Size
Width x Height
(mm x mm)

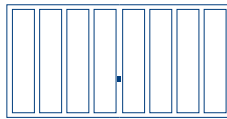

Grantham

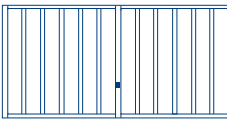

Seymour

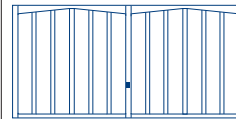

Tudor





Wolsey

	R	R	R	R
2745-3049 x 2137-2286	4510	5103	5146	5729
2745-3049 x 2287-2439	4737	5360	5409	5988
3050-3659 x 1931-1981	4989	5570	5646	6227
3050-3659 x 1982-2136	5143	5721	5796	6377
3050-3659 x 2137-2286	5585	6233	6308	6886
3050-3659 x 2287-2439	5864	6543	6622	7197
3660-4269 x 1931-1981	5810	6725	6802	7384
3660-4269 x 1982-2136	6034	6954	7029	7604
3660-4269 x 2137-2286	6340	7300	7381	7959
3660-4269 x 2287-2439	6641	7648	7728	8309
4270-5000 x 1931-1981	-	-	8190	8770
4270-5000 x 1982-2136	-	-	8267	8844

Orders for purpose made sizes will only be accepted as nominal door size for unframed version and overall frame size when ordering a framed version. Orders for purpose made framed doors will not be accepted as nominal door size.

For further options please see page 35.

Timber door window options Prices in £ stated per door						
	Standard		Georgian ¹		Diagonal ¹	
	Single doors	Double doors	Single doors	Double doors	Single doors	Double doors
Plain	no on-cost	no on-cost	170	235	170	235
Crystal	no on-cost	no on-cost	170	235	170	235

¹ Only available on Sandhurst.

Windows are manufactured from 4 mm acrylic panes. Please state on order if clear or stippled panes required.

Options	Single doors	Double doors
	add	add
Factory pre-framed standard single doors	178	-
Steel frame for standard double doors	-	267
Factory pre-framed purpose-made single doors	201	-
Steel frame for purpose-made double doors	-	297
Additional Lock Kit, C-type/ R-type (fitted onto door)	83	-
Factory fully finished stain in Light Oak, Antique Oak, Mahogany, Walnut, Chestnut and Ebony	232	343
Factory white primer ready for on-site painting	314	479
Factory fully finished painting (any RAL colour timber only)	519	900
Diecast metal handles with matching base plates: brass effect, chrome effect, brushed steel and white	124	124
Bottom weatherseal, 2405 mm length (suitable for gaps up to 15 mm between the door and the floor level)	61	61
Bottom weatherseal, 3000 mm length (suitable for gaps up to 15 mm between the door and the floor level)	67	67
Surcharge for colour steel Chassis and/or frame finished in RAL colour (no additional charge for Brown RAL8028 or White RAL9016 chassis and frame)	176	275

Please note, retractable plus lifting gear is not available on timber up and over garage doors.

Steel and Timber Garage Side Doors

Surface

Steel doors constructed around a strong steel box section chassis in Traffic White (RAL 9016) as standard. Timber doors constructed using timber, built around a strong steel box section chassis. A range of stain options are available.







Handle

Supplied with lever/lever handle on left side (viewed outside)

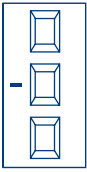
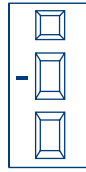
Terminology

Nominal Door Size: This is the actual door panel size plus the fitting tolerances. The nominal door size should be used for internal dimensions of a timber frame.

Size Code: This has traditionally been used to order doors. This may not be the actual door size.



Steel door - standard sizes									
Nominal Door Size Width x Height (mm x mm)	Overall frame size (between fix) ¹ Width x Height (mm x mm)	Size Code	Georgian	Beaumont	Cathedral	Beaumont with Windows ²	Carlton	Ascot	Windsor
732 x 1905	882 x 1991	2664	1094	1094	1094	1206	905	1094	1094
732 x 1955	882 x 2041	2666	1115	1115	1115	1225	924	1115	1115
732 x 2110	882 x 2196	2670	1142	1142	1142	1254	950	1142	1142
884 x 1905	1034 x 1991	3064	1133	1133	1133	1244	940	1133	1133
884 x 1955	1034 x 2041	3066	1154	1154	1154	1262	962	1154	1154
884 x 2110	1034 x 2196	3070	1183	1183	1183	1295	992	1183	1183
1037 x 1905	1187 x 1991	3664	1171	1171	1171	1284	979	1171	1171
1037 x 1955	1187 x 2041	3666	1194	1194	1194	1301	1001	1194	1194
1037 x 2110	1187 x 2196	3670	1218	1218	1218	1332	1028	1218	1218
1170 x 1905	1320 x 1991	4064	1210 ³	1210 ³	1210 ³	1318 ³	1017	1210	1210
1170 x 1955	1320 x 2041	4066	1228 ³	1228 ³	1228 ³	1340 ³	1039	1228	1228
1170 x 2110	1320 x 2196	4070	1241 ³	1241 ³	1241 ³	1351 ³	1064	1241	1241

¹ No fitting clearance allowed.

² Windows for Beaumont: Standard () , Diamond () , Cross () . Please state on order if plain or crystal panes.

³ Doors over 1210 mm overall frame width have two vertical columns of panel pressings. These doors vary from images shown.

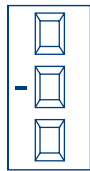
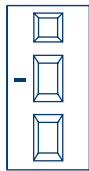
Steel door - purpose-made sizes

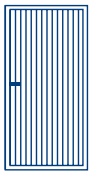
Nominal Door Size Width x Height (mm x mm)	Overall frame size (between fix) ¹ Width x Height (mm x mm)	 Georgian ³	 Beaumont ³	 Cathedral ³	 Beaumont with Windows ^{2,3}	 Carlton
670-1036 x 1905-2110	820-1186 x 1991-2196	1363 ⁴	1363 ⁴	1363 ⁴	1519 ⁴	1194
1037-1310 x 1905-2110	1187-1320 x 1991-2196	1440	1440	1440	1594	1266

¹ No fitting clearance allowed.



² Windows for Beaumont: Standard , Diamond , Cross . Please state on order if plain or crystal panes.

³ Purpose-made Georgian, Beaumont and Cathedral models have two panel pressings on door design when overall frame width is over 1210 mm.

⁴ Cathedral, Beaumont and Georgian are available at a minimum overall frame size of 882 mm.

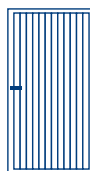
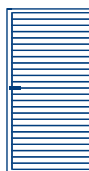
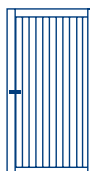

All doors come factory pre-framed, right hand hinged with the handle on the left as standard (viewed from outside).
Supplied with lever/lever handle set. Doors only available to open outwards.

Timber door - standard sizes

Nominal Door Size Width x Height (mm x mm)	Overall frame size (between fix) ¹ Width x Height (mm x mm)	Size Code	 Vertical Timber	 Horizontal Timber	 Kingsbury	 Seymour
732 x 1905	882 x 1991	2664	2653	2717	2884	2653
732 x 1955	882 x 2041	2666	2688	2750	2912	2688
732 x 2110	882 x 2196	2670	2735	2791	2954	2735
884 x 1905	1034 x 1991	3064	2750	2807	2968	2750
884 x 1955	1034 x 2041	3066	2777	2835	3001	2777
884 x 2110	1034 x 2196	3070	2822	2884	3041	2822
1037 x 1905	1187 x 1991	3664	2835	2895	3064	2835
1037 x 1955	1187 x 2041	3666	2865	2928	3089	2865
1037 x 2110	1187 x 2196	3670	2912	2968	3133	2912
1170 x 1905	1320 x 1991	4064	2928	2983	3146	2928
1170 x 1955	1320 x 2041	4066	2954	3017	3180	2954
1170 x 2110	1320 x 2196	4070	3001	3064	3217	3001

¹ No fitting clearance allowed.

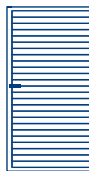
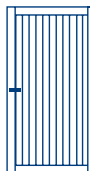
Timber door - purpose-made sizes

Nominal Door Size Width x Height (mm x mm)	Overall frame size (between fix) ¹ Width x Height (mm x mm)	 Vertical Timber	 Horizontal Timber	 Kingsbury ²	 Seymour
670-1036 x 1905-2110	820-1186 x 1991-2196	3206	3268	3428	3206
1037-1310 x 1905-2110	1187-1320 x 1991-2196	3384	3443	3601	3384

¹ No fitting clearance allowed.

² Minimum overall frame width for Kingsbury is 826 mm.

Steel, Timber and GRP Side-hinged Doors

Surface

Steel Side-hinged doors are constructed around a strong steel box section chassis in Traffic White (RAL 9016) as standard. Timber doors constructed using timber, built around our steel box section chassis. A range of stain options are available.

Pre-Framed Design and Concealed Hinges

All doors come factory pre-framed with 75mm wide door frame and right-hand door leaf leading as standard. Hinges are concealed in the frame, with no hinge knuckles protruding above the surface of the door.

Two-Point Locking

A shoot bolt latch is used to secure the fixed door leaf at the top and bottom.

Door Stays and Gas Pistons

Supplied complete with solid metal door stays and pull cord release. Gas pistons are fitted to each door leaf for a controlled closing motion.

Rubber weather seals

Sturdy rubber weather seals all built into the door frame and along the door stop on the fixed and leading door leaf.

Aluminium threshold

A 20 mm aluminium threshold is supplied as standard at the base of the door.

Steel Colours

Standard colours are:

- Traffic White (RAL 9016)

Optional colours available on an approximate 4 week lead-time:

- | | | | |
|--------------------------|------------------------------|--------------------------|-----------------------------|
| - Light Ivory (RAL 1015) | - Moss Green (RAL 6005) | - Light grey (RAL 7035) | - Burgundy Brown |
| - Ruby Red (RAL 3003) | - Fir Green (RAL 6009) | - Agate Grey (RAL 7038) | - Golden Brown |
| - Signal Blue (RAL 5005) | - Slate Grey (RAL 7015) | - Window Grey (RAL 7040) | - Chartwell Green (BS 4800) |
| - Steel Blue (RAL 5011) | - Anthracite Grey (RAL 7016) | - Terra Brown (RAL 8028) | |
| - Pigeon Blue (RAL 5014) | - Stone Grey (RAL 7030) | - Jet Black (RAL 9005) | |

Timber Stains

Full finished stains available as an option. Stain colours include Light Oak, Antique Oak, Mahogany, Walnut, Chestnut and Ebony

GRP Colours

White, Magnolia, Bleached Oak, Red Mahogany, Dark Mahogany, Light Oak, Dark Oak, Irish Oak, Honey Beech, Teak, Rosewood, Golden Brown, Ebony, Anthracite Grey, Green, Blue, Gloss White and Gloss Magnolia.

Handle

Supplied with black lever/ lever handle on right side (viewed outside) and centrally located flip-up handle which releases shoot-bolt latches at the top and bottom of the fixed leaf (viewed inside).

Terminology

Nominal Door Size: This is the actual door panel size plus the fitting tolerances. The nominal door size should be used for internal dimensions of a timber frame.

Size Code: This has traditionally been used to order doors. This may not be the actual door size.



Packaging

All doors are supplied wrapped. Only steel doors are supplied unwrapped as standard with optional poly-wrapping available.

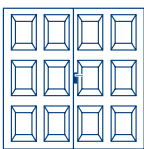
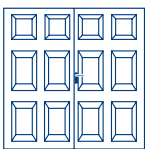
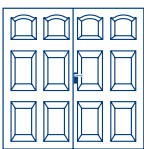
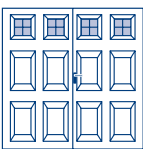
Steel door - standard sizes

Nominal Door Size Width x Height (mm x mm)	Overall frame size (between fix) ¹ Width x Height (mm x mm)	Size Code				
			Georgian	Beaumont	Cathedral	Beaumont with Windows ²
1780 x 1806	1930 x 1891	6060	-	-	-	-
1934 x 1806	2084 x 1891	6660	-	-	-	-
1934 x 1907	2084 x 1991	6664	-	-	-	-
1934 x 1957	2084 x 2041	6666	-	-	-	-
1934 x 2112	2084 x 2196	6670	-	-	-	-
2084 x 1806	2234 x 1891	7060	-	-	-	-
2084 x 1907	2234 x 1991	7064	2155	2155	2155	2574
2084 x 1957	2234 x 2041	7066	2155	2155	2155	2574
2084 x 2112	2234 x 2196	7070	2187	2187	2187	2608
2209 x 1907	2359 x 1991	7564	2254	2254	2254	2676
2209 x 1957	2359 x 2041	7566	2254	2254	2254	2676
2209 x 2112	2359 x 2196	7570	2290	2290	2290	2709
2234 x 1907	2384 x 1991	7664	2290	2290	2290	2709
2234 x 1957	2384 x 2041	7666	2290	2290	2290	2709
2234 x 2112	2384 x 2196	7670	2320	2320	2320	2740
2389 x 1907	2539 x 1991	8064	2390	2390	2390	2809
2389 x 1957	2539 x 2041	8066	2390	2390	2390	2809
2389 x 2112	2539 x 2196	8070	2419	2419	2419	2840

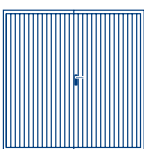
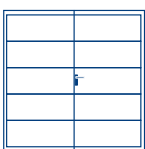
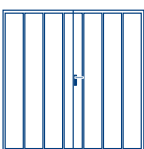
Steel door - standard sizes

Nominal Door Size Width x Height (mm x mm)	Overall frame size (between fix) ¹ Width x Height (mm x mm)	Size Code					
			Carlton	Ascot	Windsor	Salisbury Version 1	Salisbury Version 2
1780 x 1806	1930 x 1891	6060	1894	-	-	-	-
1934 x 1806	2084 x 1891	6660	1925	-	-	-	-
1934 x 1907	2084 x 1991	6664	1958	-	-	-	-
1934 x 1957	2084 x 2041	6666	1958	-	-	-	-
1934 x 2112	2084 x 2196	6670	1995	-	-	-	-
2084 x 1806	2234 x 1891	7060	1995	-	-	-	-
2084 x 1907	2234 x 1991	7064	2026	2155	2155	-	-
2084 x 1957	2234 x 2041	7066	2026 ³	2155	2155	2855	-
2084 x 2112	2234 x 2196	7070	2059 ³	2187	2187	2855	-
2209 x 1907	2359 x 1991	7564	2126	2254	2254	-	-
2209 x 1957	2359 x 2041	7566	2126	2254	2254	-	-
2209 x 2112	2359 x 2196	7570	2155	2290	2290	-	-
2234 x 1907	2384 x 1991	7664	2155	2290	2290	-	-
2234 x 1957	2384 x 2041	7666	2155	2290	2290	-	2913
2234 x 2112	2384 x 2196	7670	2187	2320	2320	-	2913
2389 x 1907	2539 x 1991	8064	2254	2390	2390	-	-
2389 x 1957	2539 x 2041	8066	2254	2390	2390	-	2913
2389 x 2112	2539 x 2196	8070	2290	2419	2419	-	2913

¹ No fitting clearance allowed.

² Windows for Beaumont: Standard , Diamond , Cross . Please state on order if plain or crystal panes.

³ Carlton 7066 and 7070 stock door only available as Traffic White (RAL 9016) with right-hand leading.

All doors come factory pre-framed, right hand door leaf leading as standard (viewed from the outside) with lever/lever handle set.

Ascot, Windsor and Salisbury side-hinged garage doors are only available in 50/ 50 door leaf configuration.

The above doors are shown as 50/50 door leaves configuration. Up to 2234 mm overall frame width these doors are also available as a 1/3 2/3 door configuration. Prices are the same but please be aware panel configurations on Georgian, Beaumont & Cathedral doors will have 3 pressing columns with increased spacing between the pressing (1/3 2/3 is a term used to describe these doors but please note the 1/3 door leaf is always 800 mm wide with the 2/3 element varying to make the desired overall width). 1/3 leaf is always leading.

Steel door - purpose-made sizes

Overall frame size
(between fix)¹
Width x Height
(mm x mm)

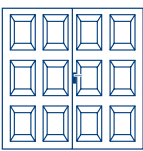
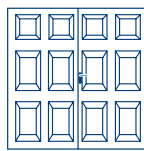
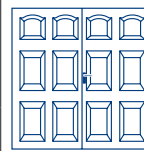
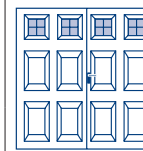
	 Georgian	 Beaumont	 Cathedral	 Beaumont with Windows ²
1930 - 2234 x 1891 - 2041	-	-	-	-
1930 - 2234 x 2042 - 2196	-	-	-	-
2235 - 2384 x 1891 - 1990	-	-	-	-
2235 - 2384 x 1991 - 2041	2402	2402	2402	2922
2235 - 2384 x 2042 - 2196	2427	2427	2427	2946
2385 - 2539 x 1891 - 1990	-	-	-	-
2385 - 2539 x 1991 - 2041	2536	2536	2536	3050
2385 - 2539 x 2042 - 2196	2563	2563	2563	3082

Steel door - purpose-made sizes

Overall frame size
(between fix)¹
Width x Height
(mm x mm)

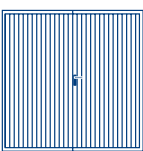
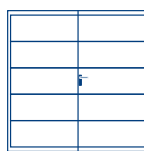
	 Carlton	 Ascot
1930 - 2234 x 1891 - 2041	2143	-
1930 - 2234 x 2042 - 2196	2198	-
2235 - 2384 x 1891 - 1990	2223	-
2235 - 2384 x 1991 - 2041	2290	2402
2235 - 2384 x 2042 - 2196	2332	2427
2385 - 2539 x 1891 - 1990	2313	-
2385 - 2539 x 1991 - 2041	2400	2536
2385 - 2539 x 2042 - 2196	2429	2563

¹ No fitting clearance allowed.

² Windows for Beaumont: Standard () , Diamond () , Cross () . Please state on order if plain or crystal panes.

All doors come factory pre-framed, right hand door leaf leading as standard (viewed from the outside) with lever/lever handle set.



Ascot and Windsor side-hinged garage doors are only available in 50/ 50 door leaf configuration.

The above doors are shown as 50/50 door leaves configuration. Up to 2234 mm overall frame width these doors are also available as a 1/3 2/3 door configuration. Prices are the same but please be aware panel configurations on Georgian, Beaumont & Cathedral doors will have 3 pressing columns with increased spacing between the pressing (1/3 2/3 is a term used to describe these doors but please note the 1/3 door leaf is always 800 mm wide with the 2/3 element varying to make the desired overall width). 1/3 leaf is always leading.

Timber door - standard sizes

Nominal Door Size Width x Height (mm x mm)	Overall frame size (between fix) ¹ Width x Height (mm x mm)	Size Code					
			Vertical Timber ²	Horizontal Timber ²	Kingsbury ³	Seymour ³	Tudor ³
1780 x 1806	1930 x 1891	6060	4353	4439	4853	4131	4131
1934 x 1806	2084 x 1891	6660	4407	4499	4853	4186	4186
1934 x 1907	2084 x 1991	6664	4407	4499	4853	4186	4186
1934 x 1957	2084 x 2041	6666	4448	4540	4867	4228	4228
1934 x 2112	2084 x 2196	6670	4448	4540	4924	4228	4228
2084 x 1806	2234 x 1891	7060	4520	4609	4924	4298	4298
2084 x 1907	2234 x 1991	7064	4534	4624	4958	4312	4312
2084 x 1957	2234 x 2041	7066	4550	4637	5016	4323	4323
2084 x 2112	2234 x 2196	7070	4550	4637	5045	4323	4323
2209 x 1907	2359 x 1991	7564	4587	4681	5197	4372	4372
2209 x 1957	2359 x 2041	7566	4600	4696	5228	4383	4383
2209 x 2112	2359 x 2196	7570	4629	4716	5322	4407	4407
2234 x 1907	2384 x 1991	7664	4587	4681	5213	4372	4372
2234 x 1957	2384 x 2041	7666	4600	4696	5277	4383	4383
2234 x 2112	2384 x 2196	7670	4629	4717	5380	4407	4407
2389 x 1907	2539 x 1991	8064	4768	4859	5683	4550	4550
2389 x 1957	2539 x 2041	8066	4780	4873	5711	4563	4563
2389 x 2112	2539 x 2196	8070	4799	4882	5862	4573	4573

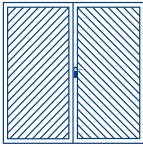
Timber door - standard sizes

Nominal Door Size Width x Height (mm x mm)	Overall frame size (between fix) ¹ Width x Height (mm x mm)	Size Code			
			Chevron Timber ³	Ashton ^{3,4}	Ashton Chevron ^{3,4}
1780 x 1806	1930 x 1891	6060	4853	5213	5446
1934 x 1806	2084 x 1891	6660	4853	5213	5446
1934 x 1907	2084 x 1991	6664	4853	5213	5446
1934 x 1957	2084 x 2041	6666	4867	5228	5456
1934 x 2112	2084 x 2196	6670	4924	5277	5516
2084 x 1806	2234 x 1891	7060	4924	5277	5516
2084 x 1907	2234 x 1991	7064	4958	5322	5557
2084 x 1957	2234 x 2041	7066	5016	5380	5611
2084 x 2112	2234 x 2196	7070	5045	5402	5641
2209 x 1907	2359 x 1991	7564	5197	5557	5790
2209 x 1957	2359 x 2041	7566	5228	5582	5822
2209 x 2112	2359 x 2196	7570	5322	5683	5918
2234 x 1907	2384 x 1991	7664	5213	5569	5807
2234 x 1957	2384 x 2041	7666	5277	5641	5874
2234 x 2112	2384 x 2196	7670	5380	5733	5975
2389 x 1907	2539 x 1991	8064	5683	6040	6278
2389 x 1957	2539 x 2041	8066	5711	5595	6308
2389 x 2112	2539 x 2196	8070	5862	6221	6455

¹ No fitting clearance allowed.

² The above doors are shown as 50/50 door leaves configuration. Up to 2234 mm overall frame width these doors are also available as a 1/3 2/3 door configuration on Vertical Timber and Horizontal Timber doors.

Prices are the same but please be aware panel configurations may be different from those shown above (1/3 2/3 is a term used to describe these doors but please note the 1/3 door leaf is always 800 mm wide with the 2/3 element varying to make the desired overall width). 1/3 leaf is always leading.

³ Not available in 70/30 configuration. Only Vertical Timber and Horizontal Timber Side Hinged doors are available in 70/30 configuration up to 7'0" wide.

⁴ On doors with windows, please state on order if plain or crystal panes.

Timber door - purpose-made sizes

Overall frame size
(between fix)¹
Width x Height
(mm x mm)

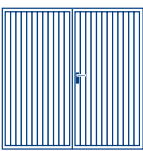
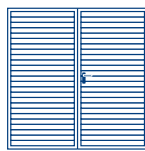
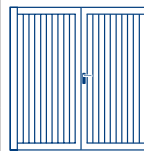
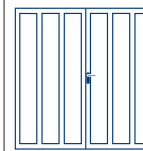
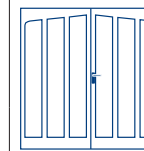

	 Vertical Timber ²	 Horizontal Timber ²	 Kingsbury ³	 Seymour ³	 Tudor ³
1930 - 2234 x 1891 - 2041	4627	4717	5101	4423	4423
1930 - 2234 x 2042 - 2196	4717	4811	5196	4515	4515
2235 - 2384 x 1891 - 2041	4807	4903	5292	4610	4610
2235 - 2384 x 2042 - 2196	4936	5029	5657	4735	4735
2385 - 2539 x 1891 - 2041	5196	5292	5927	4994	4994
2385 - 2539 x 2042 - 2196	5275	5375	6023	5071	5071

¹ No fitting clearance allowed.

² On doors with windows, please state on order if plain or crystal panes.

Timber door - purpose-made sizes

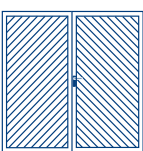
Overall frame size
(between fix)¹
Width x Height
(mm x mm)

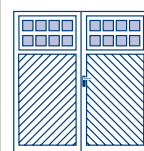
	 Chevron Timber ³	 Ashton ^{3,4}	 Ashton Chevron ^{3,4}
1930 - 2234 x 1891 - 2041	5101	5452	5684
1930 - 2234 x 2042 - 2196	5196	5552	5779
2235 - 2384 x 1891 - 2041	5292	5643	5874
2235 - 2384 x 2042 - 2196	5657	6029	7358
2385 - 2539 x 1891 - 2041	5927	6300	6543
2385 - 2539 x 2042 - 2196	6023	6384	6630

¹ No fitting clearance allowed.



² The above doors are shown as 50/50 door leaves configuration. Up to 2234 mm overall frame width these doors are also available as a 1/3 2/3 door configuration on Vertical Timber and Horizontal Timber doors.

Prices are the same but please be aware panel configurations may be different from those shown above (1/3 2/3 is a term used to describe these doors but please note the 1/3 door leaf is always 800 mm wide with the 2/3 element varying to make the desired overall width). 1/3 leaf is always leading.

³ Not available in 70/30 configuration. Only Vertical Timber and Horizontal Timber Side Hinged doors are available in 70/30 configuration up to 7'0" wide.

⁴ On doors with windows, please state on order if plain or crystal panes.

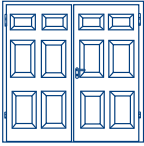
GRP door - standard sizes

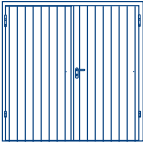
Nominal Door Size (between fix) ¹ Width x Height (mm x mm)	Overall frame size (between fix) ¹ Width x Height (mm x mm)	Size Code				
			Dorchester ²	Kenmore	Arden	Somerset ³
1780 x 1806	1930 x 1891	6060	-	-	-	3782
1934 x 1806	2084 x 1891	6660	-	-	-	3782
1934 x 1907	2084 x 1991	6664	-	-	-	3782
1934 x 1957	2084 x 2041	6666	-	-	-	3782
1934 x 2112	2084 x 2196	6670	-	-	-	3782
2084 x 1806	2234 x 1891	7060	-	-	-	3830
2084 x 1907	2234 x 1991	7064	-	-	-	3830
2084 x 1957	2234 x 2041	7066	-	-	-	3882
2084 x 2112	2234 x 2196	7070	-	-	-	3882
2209 x 1907	2359 x 1991	7564	4004	4004	4004	4004
2209 x 1957	2359 x 2041	7566	4004	4004	4004	4004
2209 x 2112	2359 x 2196	7570	4004	4004	4004	4004
2234 x 1907	2384 x 1991	7664	4004	4004	4004	4004
2234 x 1957	2384 x 2041	7666	4004	4004	4004	4004
2234 x 2112	2384 x 2196	7670	4004	4004	4004	4004
2389 x 1907	2539 x 1991	8064	4128	4128	4128	4128
2389 x 1957	2539 x 2041	8066	4128	4128	4128	4128
2389 x 2112	2539 x 2196	8070	4128	4128	4128	4128

GRP door - purpose-made sizes

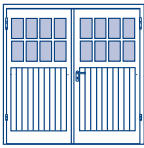
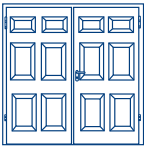
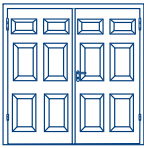
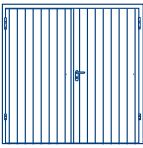
Overall frame size (between fix) ¹ Width x Height (mm x mm)				
	Dorchester ²	Kenmore	Arden	Somerset ³
1930 - 2234 x 1891 - 2041	-	-	-	4456
1930 - 2234 x 2042 - 2196	-	-	-	4539
2235 - 2384 x 1891 - 2041	-	-	-	4623
2235 - 2384 x 2042 - 2196	-	-	-	4708
2385 - 2539 x 1891 - 2041 ¹	4791	4791	4791	4791
2385 - 2539 x 2042 - 2196	4869	4869	4869	4869

¹ Please note Dorchester, Kenmore and Arden side-hinged garage doors have a minimum overall frame size of 2359 mm x 1980 mm.

² For Dorchester side-hinged garage doors, only clear glazing or stippled glazing available for windows.

³ The Somerset GRP side-hinged garage door is also available in a 70/30 configuration. All other GRP side-hinged garage doors are only available in 50/50 configuration.

Options	Steel		Timber		GRP	
	Garage side doors add	Side-hinged doors add	Garage side doors add	Side-hinged doors add	Garage side doors add	Side-hinged doors add
For powder-coated steel doors ¹ : - Moss Green (RAL 6005) - Ruby Red (RAL 3003) - Signal Blue (RAL 5005) - Jet Black (RAL 9005) - Steel Blue (RAL 5011) - Light Ivory (RAL 1015) - Pigeon Blue (RAL 5014) - Fir Green (RAL 6009) - Anthracite Grey (RAL 7016) - Stone Grey (RAL 7030) - Light Grey (RAL 7035) - Slate Grey (RAL 7015) - Agate Grey (RAL 7038) - Window Grey (RAL 7040) - Chartwell Green (BS 4800) - Burgundy Brown - Golden Brown - Terra Brown (RAL 8028)	135	176	-	-	-	-
Colour matched windows for Salisbury side-hinged doors ²	-	221	-	-	-	-
Black window panes for Salisbury doors (price per door)	-	50	-	-	-	-
Coloured window frames to match door colour – Beaumont doors (price per window). Beaumont doors up to 2539 mm wide = 4 windows ³ .	65 each	65 each	-	-	-	-
Surcharge for Premium GRP colours: - Green - Blue	-	-	-	-	-	811
Handles for steel and timber doors: - knob/lever black plastic	45	45	45	45	45	45
For timber doors: factory fully finished in - Light Oak - Antique Oak - Mahogany - Walnut - Chestnut - Ebony	-	-	188	285	-	-
Factory white primer ready for on-site painting	-	-	285	350	-	-
Factory fully finished painting (any RAL colour)	-	-	471	585	-	-
Anodised Aluminium lever/lever handles: - white	166	166	166	166	-	166
Anodised Aluminium lever/lever handles: - chrome effect	207	207	207	207	-	207
Left hand leading	121	121	121	121	-	121
Fitting compensation kit (part no. 8261)	184	184	184	184	184	184
Poly-wrapping	47	47	-	-	-	-

¹ Coloured Beaumont with windows doors are supplied with white window frames as standard.

² Only available on steel side-hinged doors.

³ Colour match windows not available in Burgundy Brown or Golden Brown.

For timber side-hinged doors chassis is either Traffic White (RAL 9016) or Terra Brown (RAL 8028) regardless of exact colour of timber finishing, there is a charge of £176, except when Ebony finishing is ordered and then the chassis will be supplied in black.

Garage Side Doors & Side-hinged Doors – Specifications

Door leaves supplied factory pre-framed ready for site installation. Fixed leaf (RH side when viewed from inside) fitted with tower bolts at top and bottom of inner leading edge. The floor will need to be finished and level for the bottom tower bolts to engage. These doors are designed for in-between fixing.

Garage Side door factory pre-framed

Between brickwork fixing

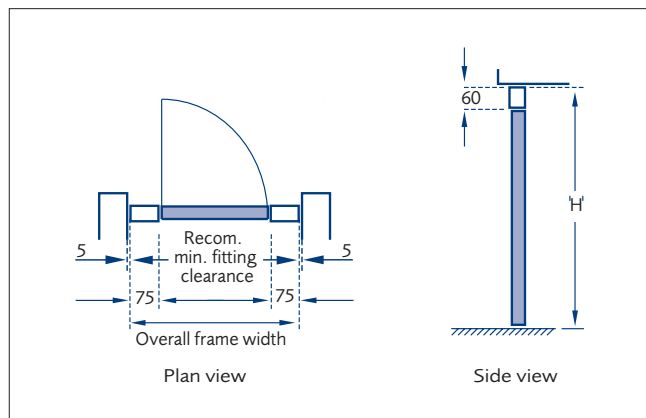

Door specification

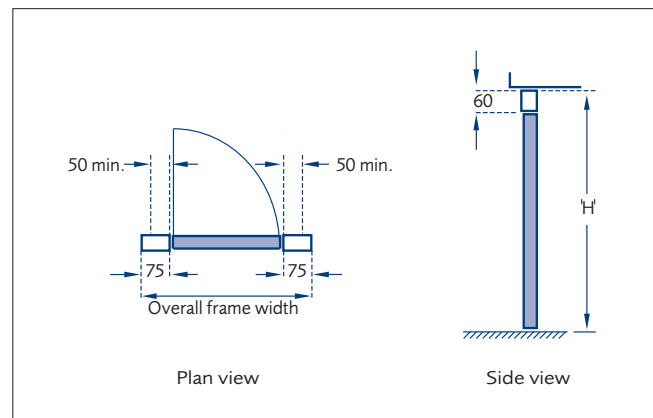

The nominal clear passage clearance is 74 mm less than the opening width and 125 mm less than the opening height.
Not recommended for behind brickwork fixing.

Side-hinged door factory pre-framed

Between brickwork fixing

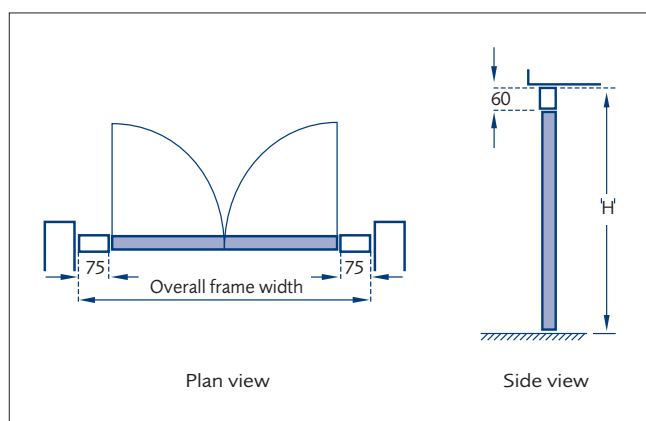

Door specification

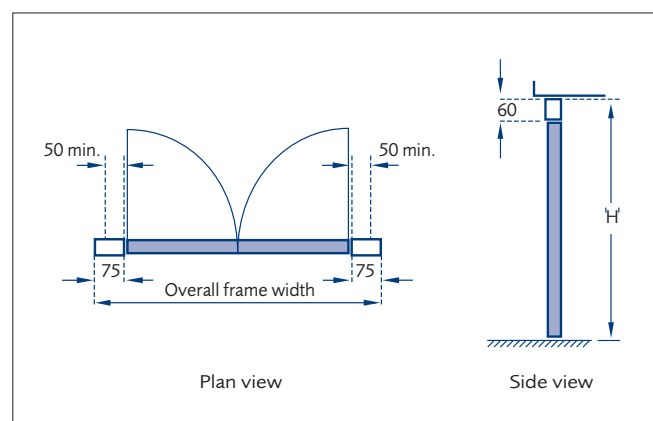

The nominal drive through clearance is 30 mm less than the opening width and 125 mm less than the opening height.
Not recommended for behind brickwork fixing.

Side-Hinged Garage Door Steel Frame Specifications

	Width	Height	Depth
Side-Hinged Doors	75 mm	60 mm	75 mm

Steel Panel Doors – Specifications

Canopy Gear Specifications

The canopy gear allows the door to travel in vertical tracks and is counterbalanced by an overhead torsion spring. The nominal drive through is 40 mm less than the opening width and 130 mm less than the opening height.

In the open position, the door projects approximately one third of the door height, forming a canopy.

For doors fitted with an operator, please observe operator specifications.

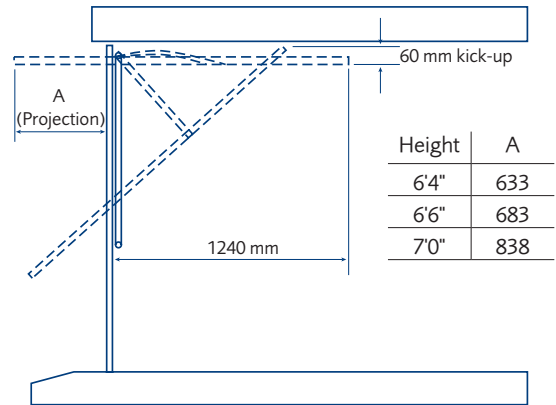

On-site timber frame

Behind brickwork fixing

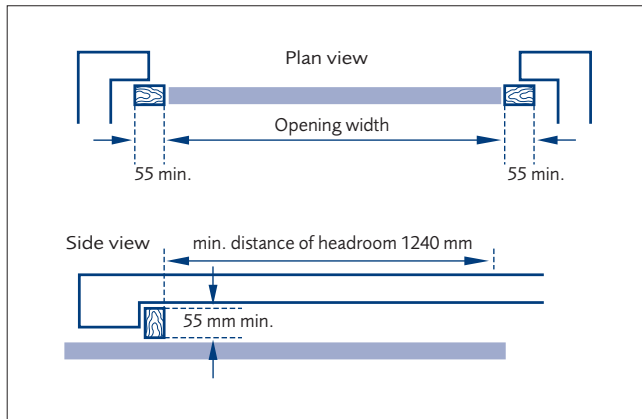

Between brickwork fixing

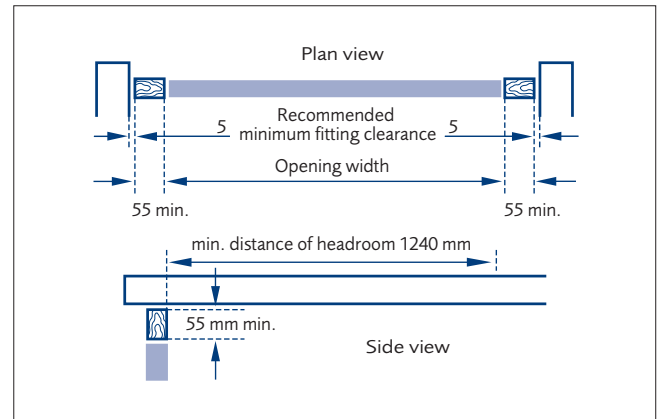

Factory pre-framed with steel box frame

The garage door is supplied factory fitted to a steel box section frame and is secured to the brickwork by using just 7 fixings.

Behind brickwork fixing

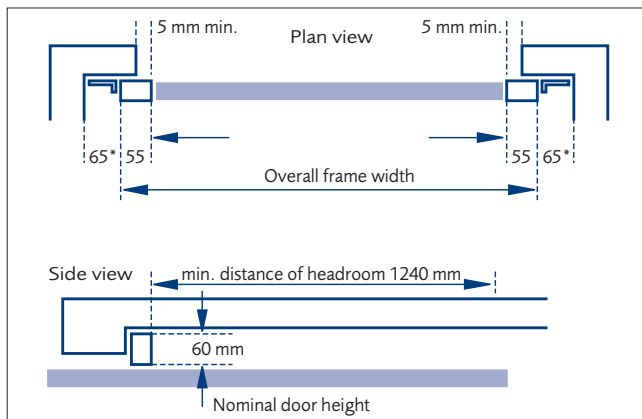

* width of anchor brackets in this position

Between brickwork fixing

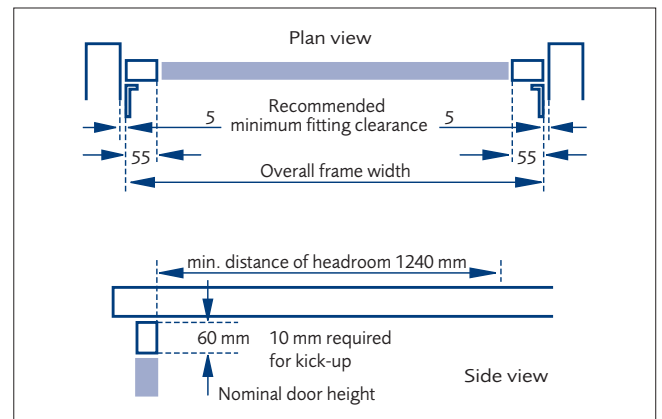

Up & Over Garage Door Steel Frame Dimensions

	Width	Depth
Canopy steel frame (single door)	60 mm	40 mm
Retractable steel frame (single door)	75 mm	40 mm
Retractable steel frame (double door)	75 mm	80 mm

Single & Double Retractable Gear Specifications

The retractable gear allows the door to be retracted inside the garage when open by means of horizontal overhead tracks supported by wall or ceiling mounted suspension brackets. This gear is available as an option for single doors and comes as standard with double garage doors.

The nominal drive through clearance is 105 mm less than the opening width and 110 mm less than the opening height for single doors and 140 mm less than the opening height for double doors.

For doors fitted with an operator, please observe operator specifications.

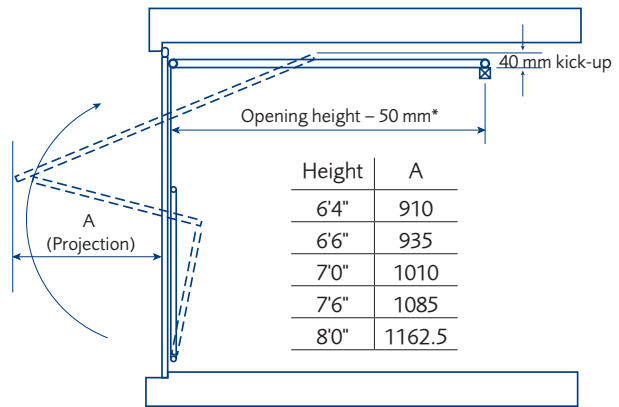

* Only applies to single doors up to 1070.

On-site timber frame

Behind brickwork fixing

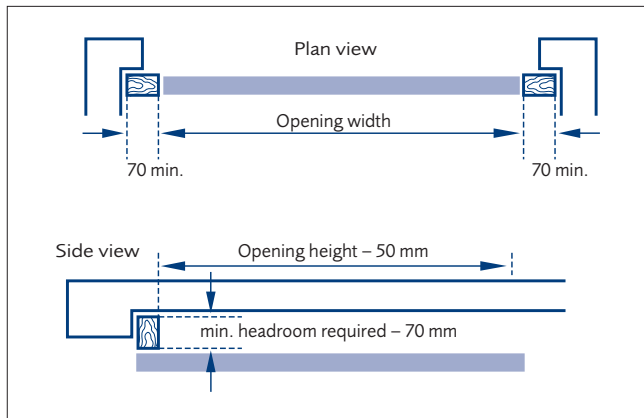

Between brickwork fixing

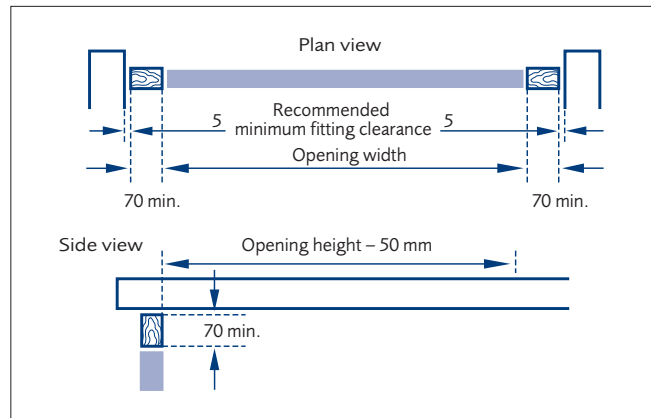

Factory pre-framed with steel box frame

The garage door is supplied factory fitted to a steel box section frame and is secured to the brickwork by using just 7 fixings.

Behind brickwork fixing

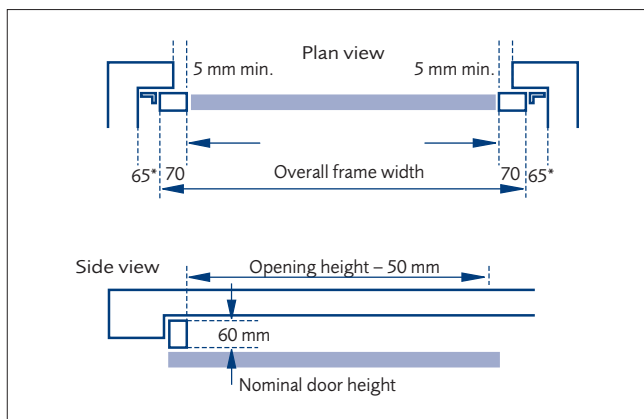

* width of anchor brackets in this position

Between brickwork fixing

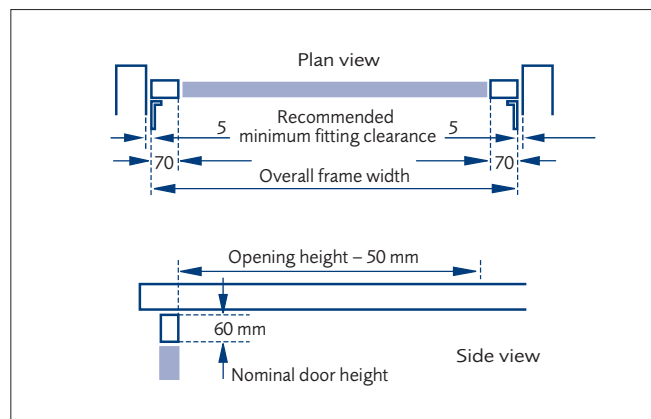

Retractable Plus Gear

For any door up to a width of 2744 mm in any of the three standard heights Retractable Plus Gear is available. This gear type creates clear drive through width at the crucial wing mirror height.

Door height	Clear height below lifting arms
7'0"	1260
6'6"	1105
6'4"	1055

Steel Sectional Garage Doors

Door sections

Made of galvanised steel. Premium doors have a 42 mm thick insulated door section that is filled with PU-foam (100 % CFC-free). Bottom door section comes with floor seal.

Surface

Outside: Woodgrain embossed, Slategrain, Sandgrain or Silkgrain textures with painted or foil coated finishes.
Inside: pebble texture.

Spring arrangement

All doors up to 4000 mm wide (excluding Silkgrain) come with tension springs as standard and torsion springs are available at extra cost. All doors over 4000 mm wide (excluding Silkgrain) come with torsion springs as standard. Low headroom application available at extra cost. Doors with a Silkgrain surface finish are supplied with tension springs as standard up to 3049 mm wide and torsion springs as standard on doors over 3050 mm wide.

Side frames & Fascia

Sectional doors are designed to be fitted behind the reveals and side frames are supplied white in colour. Cover profiles are available for use with coloured or foil coated door finishes. A single skin fascia is supplied with all doors which is finished in the same colour as the door sections. For Slategrain models, the door section has a Slategrain texture but the cover profiles and fascia are smooth.

Colours

Steel Woodgrain and Silkgrain doors can be ordered in almost any colour from the RAL colour chart. Slategrain is only available in standard RAL colours and Traffic White (RAL 9016).

Standard colours are:

- | | | | |
|--------------------------|------------------------------|------------------------------|------------------------------|
| - Light Ivory (RAL 1015) | - Anthracite Grey (RAL 7016) | - Quartz Grey (RAL 7039) | - Grey Aluminium (RAL 9007) |
| - Moss Green (RAL 6005) | - Titan Metallic (CH 703) | - Window Grey (RAL 7040) | - Chartwell Green (BS 14C35) |
| - Fir Green (RAL 6009) | - Stone Grey (RAL 7030) | - Terra Brown (RAL 8028) | |
| - Basalt Grey (RAL 7012) | - Light Grey (RAL 7035) | - Jet Black (RAL 9005) | |
| - Slate Grey (RAL 7015) | - Agate Grey (RAL 7038) | - White Aluminium (RAL 9006) | |

Special RAL colours are:

- | | | | |
|-------------------------|--------------------------|-----------------------------|----------------------------|
| - Black Red (RAL 3007) | - Black Grey (RAL 7021) | - Signal Black (RAL 9004) | - Traffic Black (RAL 9017) |
| - Black Blue (RAL 5004) | - Black Brown (RAL 8022) | - Graphite Black (RAL 9011) | |

Non standard RAL colours are:

Based on full RAL colour chart excluding Traffic Purple (RAL 4006), Purple Violet (RAL 4007) and pearlescent or florescent options.

Timber effect foil coated doors are available in the following five finishes:

Golden Oak, Dark Oak, Night Oak, Rosewood and Winchester Oak. Only Golden Oak and Rosewood surface finishes are kept as stock door sizes (prices highlighted in bold) for timber effect sectional garage doors. Dark Oak, Night Oak and Winchester Oak surface finishes are not stocked, but are made to order.

Foil coated finish also available in Titan Metallic (CH 703)

Handle

Sectional doors in shaded boxes are generally supplied ex-works for automatic operation, i.e. without handle hole and lock. Factory-fitted handle and lock are available with an increased lead-time. All other doors are on a 4 to 6 week lead-time. For electrical operation of a garage with no other personal access, an emergency release kit must be fitted.

Packaging

Sectional doors are provided in a palletted format shrink wrapped for easy handling.

Stock availability

Popular sectional doors are generally ex-stock in Traffic White (RAL 9016) and Terra Brown (RAL 8028) in some sizes, other sizes and colour options require up to 6 weeks lead-time. Contact sales office for further details.

Gears

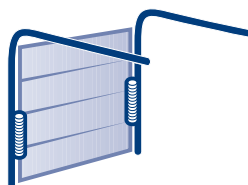

Tension spring

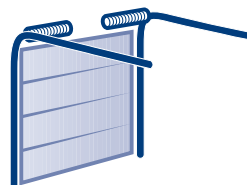

Torsion spring

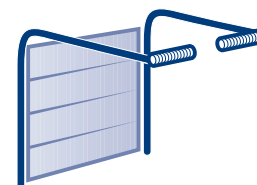

Low headroom torsion spring fitting

Window options

Georgian design

Prices £ stated per window
Window frames white as standard

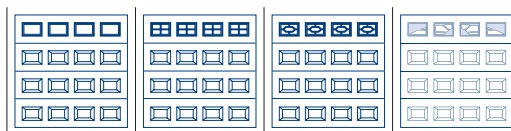

	Standard	Cross	Diamond	Sunrise
Premium - Woodgrain ¹	144	180	180	185
Premium - Timber effect ²	185	219	219	227

Linear small design

Prices £ stated per window
Window frames white as standard

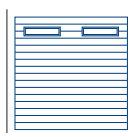

	Linear 1
Premium - Woodgrain ¹	144

Linear medium design

Prices £ stated per window
Window frames white as standard



	Standard	Cross	Diamond	Sunrise	Linear 1	Linear 2
Premium - Woodgrain Sandgrain, Silkgrain ¹ , Slategrain	144	180	180	185	144	177
Premium - Timber effect ²	185	219	219	227	185	217

Linear large design

Prices £ stated per window
Window frames white as standard



	Standard	Cross	Diamond	Sunrise	Linear 1	Linear 2	Linear 3
Premium - Sandgrain, Silkgrain, Slategrain	144	180	180	185	144	177	229
Premium - Timber effect ²	185	219	219	227	185	217	269

¹ Colours available at surcharge per window (£ 44 for standard colour, £ 72 for non standard colour, £ 137 for special RAL colour).

² Window frames are painted in a colour to best complement the colour of the foil coat (colour incl. in price).

Please note, window frames are painted in a colour to complement the colour of the sectional garage door.

Standard, Cross, Diamond and Sunrise (overall frame dimension: 395 mm x 270 mm)

Doors up to 2124 mm wide have 3 windows, 2125 mm to 2749 mm wide have 4 windows, 2750 mm to 3499 mm wide have 5 windows, 3500 mm to 3999 mm wide have 6 windows, 4000 mm to 4749 mm wide have 7 windows and doors of 4750 mm up to 5500 mm wide have 8 windows. Sunrise windows only available from 2130 mm wide doors up to 5500 mm wide doors.

Linear 1 (overall frame dimension: 680 mm x 210 mm)

Doors up to 2499 mm wide have 2 windows, 2500 mm to 3499 mm wide have 3 windows, 3500 mm to 4499 mm wide have 4 windows and doors over 4500 mm wide have 5 windows.

Linear 2 (overall frame dimension: 620 mm x 270 mm)

Doors up to 2239 mm wide have 2 windows, 2240 mm to 2969 mm wide have 3 windows, 2970 mm to 3689 mm wide have 4 windows, 3690 mm to 4419 mm wide have 5 windows and doors over 4420 mm have 6 windows.

Linear 3 (overall frame dimension: 1004 mm x 270 mm)

Door widths from 2250 mm to 3399 mm have 2 windows, 3400 mm to 4489 mm have 3 windows, 4490 mm to 5499 mm have 4 windows, 5500 mm to 6000 mm have 6 windows.

Please state on order if clear or crystal panes. Georgian sectional doors under 7 ft wide only have 3 pressings.

Secured by Design – Free optional upgrade available after installation

The following criteria must be met to be eligible for Secured by Design accreditation:

- Premium 42 mm sectional door (without windows).
- Fitted behind the opening.
- Automated with a GaraMatic operator (sold separately).
- Door must be fitted to SBD standard, unmodified and registered with Garador.



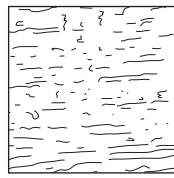
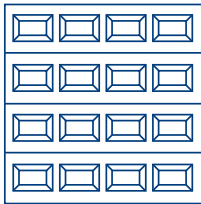

Woodgrain

Georgian design

Brickwork opening Width x Height (mm x mm)	Size Code	 Premium	Surcharge for Standard Colours	Surcharge for Non-Std. Colours	Surcharge for Special RAL
2080 x 2000	I 61066	1763	238	390	759
2080 x 2080	I 610610	1783	248	405	789
2134 x 2000	I 7066	1823	245	399	778
2134 x 2125	I 7070	1846	260	424	827
2250 x 1900	M 7462	1874	242	395	768
2250 x 2000	M 7466	1928	258	421	820
2250 x 2125	M 7470	1931	274	447	872
2286 x 2000	I 7666	1823	262	428	834
2286 x 2125	I 7670	1846	279	454	885
2286 x 2250	I 7674	1841	294	481	938
2286 x 2375	I 7679	1967	310	507	990
2286 x 2500	I 7682	1963	327	535	1042
2375 x 1900	M 7962	1874	255	417	812
2375 x 2000	M 7966	1876	272	445	867
2375 x 2125	M 7970	1881	288	471	921
2375 x 2250	M 7974	1962	306	499	974
2438 x 2000	I 8066	1924	280	455	889
2438 x 2125	I 8070	1954	297	484	944
2438 x 2250	I 8074	1941	314	512	1000
2438 x 2375	I 8079	2069	332	541	1055
2438 x 2500	I 8082	2064	349	570	1111
2500 x 1900	M 8262	1874	269	437	854
2500 x 2000	M 8266	1876	286	467	911
2500 x 2125	M 8270	1881	304	497	968
2500 x 2250	M 8274	1962	322	525	1026
2500 x 2375	M 8279	2057	340	555	1083
2500 x 2500	M 8282	2062	358	583	1140
2500 x 2750	M 8290	2233	394	642	1253
2591 x 2000	I 8666	1924	297	484	944
2591 x 2125	I 8670	1954	315	515	1003
2625 x 2125	M 8770	2036	319	521	1017
2740 x 2000	I 9066	2095	314	512	999
2740 x 2125	I 9070	2124	334	544	1062
2750 x 2000	M 9166	2272	315	515	1002
2750 x 2125	M 9170	2315	335	546	1066
2750 x 2250	M 9174	2401	354	578	1128
2750 x 2375	M 9179	2420	374	610	1191
2750 x 2500	M 9182	2501	394	642	1253
2896 x 2000	I 9666	2199	332	541	1055
2896 x 2125	I 9670	2241	352	575	1122
3000 x 2000	M 91066	2387	343	560	1093
3000 x 2125	M 91070	2385	365	596	1162
3000 x 2250	M 91074	2460	387	631	1231
3000 x 2375	M 91079	2504	408	666	1298
3000 x 2500	M 91082	2586	429	701	1367
3000 x 3000	M 910910	3362	515	840	1640
3048 x 2000	I 1066	2110	349	570	1111
3048 x 2125	I 1070	2154	371	606	1180
3250 x 2000	M 10866	2478	372	608	1185
3250 x 2125	M 10870	2545	395	645	1258
3250 x 2250	M 10874	2626	418	684	1333
3353 x 2000	I 1166	2522	383	627	1222
3353 x 2125	I 1170	2566	408	666	1298
3500 x 2000	M 11666	2699	400	654	1276

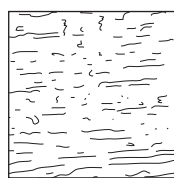
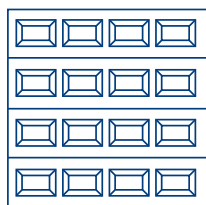

Woodgrain

Georgian design

Brickwork opening
Width x Height
(mm x mm)

Size Code



Premium

Surcharge for Standard Colours

Surcharge for Non-Std. Colours

Surcharge for Special RAL

Brickwork opening Width x Height (mm x mm)	Size Code		Surcharge for Standard Colours	Surcharge for Non-Std. Colours	Surcharge for Special RAL	
3500 x 2125	M	11670	2769	426	694	1356
3500 x 2250	M	11674	2857	451	735	1435
3658 x 2000	I	1266	2975	418	684	1333
3658 x 2125	I	1270	3023	445	726	1416
3750 x 2000	M	12466	2914	429	701	1367
3750 x 2125	M	12470	2990	455	744	1453
3750 x 2250	M	12474	3084	483	788	1539
3962 x 2000	I	1366	3094	453	741	1443
3962 x 2125	I	1370	3137	482	786	1534
4000 x 2000	M	13266	3120	457	747	1458
4000 x 2125	M	13270	3199	486	794	1549
4000 x 2250	M	13274	3301	515	840	1640
4250 x 2000	M	131166	3218	486	794	1549
4250 x 2125	M	131170	3306	517	844	1645
4250 x 2250	M	131174	3407	546	893	1742
4267 x 2000	I	1466	3217	488	796	1556
4267 x 2125	I	1470	3268	519	847	1652
4420 x 2000	I	14666	3333	506	825	1611
4420 x 2125	I	14670	3389	537	876	1711
4500 x 2000	M	14966	3306	515	840	1640
4500 x 2125	M	14970	3406	546	893	1742
4500 x 2250	M	14974	3514	579	945	1845
4572 x 2000	I	1566	3395	522	853	1667
4572 x 2125	I	1570	3450	555	907	1770
4725 x 2000	I	15666	3562	540	882	1723
4725 x 2125	I	15670	3617	574	937	1830
4750 x 2000	M	15766	3407	543	887	1731
4750 x 2125	M	15770	3507	577	942	1840
4750 x 2250	M	15774	3613	611	997	1947
4877 x 2000	I	1666	3562	557	910	1778
4877 x 2125	I	1670	3617	593	967	1888
5000 x 2000	M	16566	3502	572	933	1822
5000 x 2125	M	16570	3583	608	992	1936
5000 x 2250	M	16574	3696	643	1050	2051
5000 x 2375	M	16579	3832	679	1108	2164
5000 x 2500	M	16582	3821	714	1167	2277
5500 x 2000	M	18166	3788	629	1027	2004
5500 x 2125	M	18170	3952	668	1090	2129
5500 x 2250	M	18174	4180	707	1156	2255

Prices in bold are generally a stock item. Non-bold prices require a longer lead-time.

Purpose-made sizes available upon request. Non standard colours also available upon request. Doors supplied without locking as standard (see options on page 67 for handles). For window options please see page 49.

I Imperial door sizes.

M Metric door sizes. Extended lead time of 4-6 weeks.

Supplied as standard with tension spring gear. Torsion spring fitting available for Premium doors at £ 107 surcharge.

Supplied as standard with torsion spring gear. Low headroom fitting available at £ 176 surcharge.

Purpose-made sizes available upon request. Non standard colours also available upon request. Doors supplied without locking as standard (see options on page 67 for handles). For window options please see page 49.

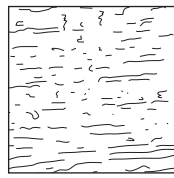
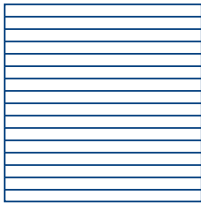

Woodgrain

Linear small design

Brickwork opening Width x Height (mm x mm)	Size Code	Premium	Surcharge for Standard Colours	Surcharge for Non-Std. Colours	Surcharge for Special RAL
2080 x 2000	I 61066	1393	238	390	759
2080 x 2080	I 610610	1444	248	405	789
2134 x 2000	I 7066	1443	245	399	778
2134 x 2125	I 7070	1492	260	424	827
2250 x 1900	M 7462	1525	242	395	768
2250 x 2000	M 7466	1572	258	421	820
2250 x 2125	M 7470	1575	274	447	872
2286 x 2000	I 7666	1443	262	428	834
2286 x 2125	I 7670	1492	279	454	885
2286 x 2250	I 7674	1513	294	481	938
2286 x 2375	I 7679	1631	310	507	990
2286 x 2500	I 7682	1628	327	535	1042
2375 x 1900	M 7962	1525	255	417	812
2375 x 2000	M 7966	1527	272	445	867
2375 x 2125	M 7970	1527	288	471	921
2375 x 2250	M 7974	1557	306	499	974
2438 x 2000	I 8066	1516	280	455	889
2438 x 2125	I 8070	1577	297	484	944
2438 x 2250	I 8074	1586	314	512	1000
2438 x 2375	I 8079	1709	332	541	1055
2438 x 2500	I 8082	1701	349	570	1111
2500 x 1900	M 8262	1525	269	437	854
2500 x 2000	M 8266	1527	286	467	911
2500 x 2125	M 8270	1527	304	497	968
2500 x 2250	M 8274	1557	322	525	1026
2500 x 2375	M 8279	1642	340	555	1083
2500 x 2500	M 8282	1645	358	583	1140
2500 x 2750	M 8290	2000	394	642	1253
2591 x 2000	I 8666	1516	297	484	944
2591 x 2125	I 8670	1577	315	515	1003
2625 x 2125	M 8770	1728	319	521	1017
2740 x 2000	I 9066	1643	314	512	999
2740 x 2125	I 9070	1699	334	544	1062
2750 x 2000	M 9166	1753	315	515	1002
2750 x 2125	M 9170	1809	335	546	1066
2750 x 2250	M 9174	1819	354	578	1128
2750 x 2375	M 9179	1868	374	610	1191
2750 x 2500	M 9182	1950	394	642	1253
2896 x 2000	I 9666	1717	332	541	1055
2896 x 2125	I 9670	1787	352	575	1122
3000 x 2000	M 91066	1967	343	560	1093
3000 x 2125	M 91070	1966	365	596	1162
3000 x 2250	M 91074	1983	387	631	1231
3000 x 2375	M 91079	2035	408	666	1298
3000 x 2500	M 91082	2119	429	701	1367
3000 x 3000	M 910910	2570	515	840	1640
3048 x 2000	I 1066	1659	349	570	1111
3048 x 2125	I 1070	1719	371	606	1180
3250 x 2000	M 10866	1978	372	608	1185
3250 x 2125	M 10870	2035	395	645	1258
3250 x 2250	M 10874	2080	418	684	1333
3353 x 2000	I 1166	1956	383	627	1222
3353 x 2125	I 1170	2035	408	666	1298
3500 x 2000	M 11666	2113	400	654	1276

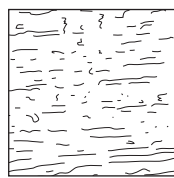
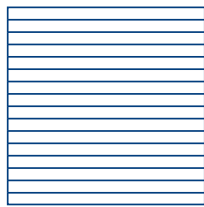

Woodgrain

Linear small design



Premium

Brickwork opening Width x Height (mm x mm)	Size Code		Surcharge for Standard Colours	Surcharge for Non-Std. Colours	Surcharge for Special RAL	
3500 x 2125	M	11670	2166	426	694	1356
3500 x 2250	M	11674	2212	451	735	1435
3658 x 2000	I	1266	2300	418	684	1333
3658 x 2125	I	1270	2390	445	726	1416
3750 x 2000	M	12466	2229	429	701	1367
3750 x 2125	M	12470	2295	455	744	1453
3750 x 2250	M	12474	2340	483	788	1539
3962 x 2000	I	1366	2386	453	741	1443
3962 x 2125	I	1370	2476	482	786	1534
4000 x 2000	M	13266	2349	457	747	1458
4000 x 2125	M	13270	2420	486	794	1549
4000 x 2250	M	13274	2471	515	840	1640
4250 x 2000	M	131166	2481	486	794	1549
4250 x 2125	M	131170	2554	517	844	1645
4250 x 2250	M	131174	2610	546	893	1742
4267 x 2000	I	1466	2475	488	796	1556
4267 x 2125	I	1470	2574	519	847	1652
4420 x 2000	I	14666	2558	506	825	1611
4420 x 2125	I	14670	2661	537	876	1711
4500 x 2000	M	14966	2608	515	840	1640
4500 x 2125	M	14970	2684	546	893	1742
4500 x 2250	M	14974	2737	579	945	1845
4572 x 2000	I	1566	2606	522	853	1667
4572 x 2125	I	1570	2708	555	907	1770
4725 x 2000	I	15666	2716	540	882	1723
4725 x 2125	I	15670	2823	574	937	1830
4750 x 2000	M	15766	2687	543	887	1731
4750 x 2125	M	15770	2765	577	942	1840
4750 x 2250	M	15774	2820	611	997	1947
4877 x 2000	I	1666	2716	557	910	1778
4877 x 2125	I	1670	2823	593	967	1888
5000 x 2000	M	16566	2766	572	933	1822
5000 x 2125	M	16570	2823	608	992	1936
5000 x 2250	M	16574	2879	643	1050	2051
5000 x 2375	M	16579	2939	679	1108	2164
5000 x 2500	M	16582	2998	714	1167	2277
5500 x 2000	M	18166	2959	629	1027	2004
5500 x 2125	M	18170	3040	668	1090	2129
5500 x 2250	M	18174	3117	707	1156	2255

Prices in bold are generally a stock item. Non-bold prices require a longer lead-time.

- I** Imperial door sizes.
- M** Metric door sizes. Extended lead time of 4-6 weeks.
- Supplied as standard with tension spring gear. Torsion spring fitting available for Premium doors at £ 107 surcharge.
- Supplied as standard with torsion spring gear. Low headroom fitting available at £ 176 surcharge.

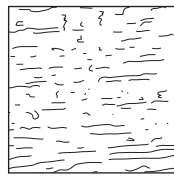
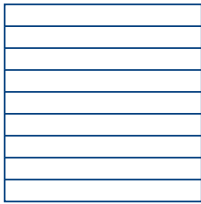

Woodgrain

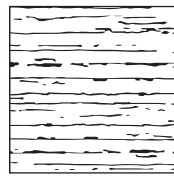
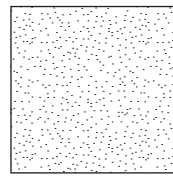
 Slategrain¹

 Silkgrain²
Linear medium design

 Brickwork
opening
Width x Height
(mm x mm)

 Size
Code

Premium



Premium







Premium

 Surcharge
for
Standard
Colours

 Surcharge
for
Non-Std.
Colours

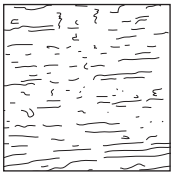
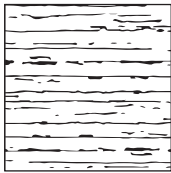
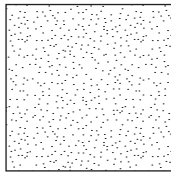
 Surcharge
for Special
RAL

Brickwork opening Width x Height (mm x mm)	Size Code	Premium	Premium	Premium	Surcharge for Standard Colours	Surcharge for Non-Std. Colours	Surcharge for Special RAL
2080 x 2000	I 61066	1393	1393	1712	238	390	759
2080 x 2080	I 610610	1444	1444	1780	248	405	789
2134 x 2000	I 7066	1443	1443	1712	245	399	778
2134 x 2125	I 7070	1492	1492	1780	260	424	827
2250 x 1900	M 7462	1492	1525	1826	242	395	768
2250 x 2000	M 7466	1572	1572	1861	258	421	820
2250 x 2125	M 7470	1575	1575	1865	274	447	872
2286 x 2000	I 7666	1443	1443	1712	262	428	834
2286 x 2125	I 7670	1492	1492	1780	279	454	885
2286 x 2250	I 7674	1513	1513	1862	294	481	938
2286 x 2375	I 7679	1631	1631	1944	310	507	990
2286 x 2500	I 7682	1628	1628	2021	327	535	1042
2375 x 1900	M 7962	1525	1525	1826	255	417	812
2375 x 2000	M 7966	1527	1527	1831	272	445	867
2375 x 2125	M 7970	1527	1527	1836	288	471	921
2375 x 2250	M 7974	1557	1557	1904	306	499	974
2438 x 2000	I 8066	1516	1516	1815	280	455	889
2438 x 2125	I 8070	1577	1577	1890	297	484	944
2438 x 2250	I 8074	1586	1586	1945	314	512	1000
2438 x 2375	I 8079	1709	1709	2037	332	541	1055
2438 x 2500	I 8082	1701	1701	2132	349	570	1111
2500 x 1900	M 8262	1525	1525	1826	269	437	854
2500 x 2000	M 8266	1527	1527	1831	286	467	911
2500 x 2125	M 8270	1527	1527	1836	304	497	968
2500 x 2250	M 8274	1557	1557	1904	322	525	1026
2500 x 2375	M 8279	1642	1642	2025	340	555	1083
2500 x 2500	M 8282	1645	1645	2023	358	583	1140
2500 x 2750	M 8290	2000	2000	-	394	642	1253
2591 x 2000	I 8666	1516	1516	1815	297	484	944
2591 x 2125	I 8670	1577	1577	1890	315	515	1003
2625 x 2125	M 8770	1728	1728	2099	319	521	1017
2740 x 2000	I 9066	1643	1643	1989	314	512	999
2740 x 2125	I 9070	1699	1699	2065	334	544	1062
2750 x 2000	M 9166	1753	1753	2063	315	515	1002
2750 x 2125	M 9170	1809	1809	2145	335	546	1066
2750 x 2250	M 9174	1819	1819	2193	354	578	1128
2750 x 2375	M 9179	1868	1868	2266	374	610	1191
2750 x 2500	M 9182	1950	1950	2369	394	642	1253
2896 x 2000	I 9666	1717	1717	2094	332	541	1055
2896 x 2125	I 9670	1787	1787	2175	352	575	1122
3000 x 2000	M 91066	1967	1967	2351	343	560	1093
3000 x 2125	M 91070	1966	1966	2353	365	596	1162
3000 x 2250	M 91074	1983	1983	2377	387	631	1231
3000 x 2375	M 91079	2035	2035	2484	408	666	1298
3000 x 2500	M 91082	2119	2119	2592	429	701	1367
3000 x 3000	M 910910	2571	2571	3138	515	840	1640
3048 x 2000	I 1066	1659	1659	2094	349	570	1111
3048 x 2125	I 1070	1719	1719	2175	371	606	1180
3250 x 2000	M 10866	1978	1978	2491	372	608	1185
3250 x 2125	M 10870	2035	2035	2562	395	645	1258
3250 x 2250	M 10874	2080	2080	2631	418	684	1333
3353 x 2000	I 1166	1956	1956	2503	383	627	1222
3353 x 2125	I 1170	2035	2035	2605	408	666	1298
3500 x 2000	M 11666	2113	2113	2647	400	654	1276
3500 x 2125	M 11670	2166	2166	2718	426	694	1356
3500 x 2250	M 11674	2212	2212	2800	451	735	1435

							
		Woodgrain	Slategrain ¹	Silkgrain ²			
Linear medium design					Surcharge for Standard Colours	Surcharge for Non-Std. Colours	Surcharge for Special RAL
Brickwork opening Width x Height (mm x mm)	Size Code	Premium	Premium	Premium			
3658 x 2000	I 1266	2300	2300	2825	418	684	1333
3658 x 2125	I 1270	2390	2390	2936	445	726	1416
3750 x 2000	M 12466	2229	2229	2708	429	701	1367
3750 x 2125	M 12470	2295	2295	2794	455	744	1453
3750 x 2250	M 12474	2340	2340	2880	483	788	1539
3962 x 2000	I 1366	2386	2386	2913	453	741	1443
3962 x 2125	I 1370	2476	2476	3023	482	786	1534
4000 x 2000	M 13266	2349	2349	2849	457	747	1458
4000 x 2125	M 13270	2420	2420	2920	486	794	1549
4000 x 2250	M 13274	2471	2471	3015	515	840	1640
4250 x 2000	M 131166	2481	2481	2970	486	794	1549
4250 x 2125	M 131170	2554	2554	3063	517	844	1645
4250 x 2250	M 131174	2610	2610	3152	546	893	1742
4267 x 2000	I 1466	2475	2475	2997	488	796	1556
4267 x 2125	I 1470	2574	2574	3120	519	847	1652
4420 x 2000	I 14666	2558	2558	3075	506	825	1611
4420 x 2125	I 14670	2661	2661	3200	537	876	1711
4500 x 2000	M 14966	2608	2608	3123	515	840	1640
4500 x 2125	M 14970	2684	2684	3220	546	893	1742
4500 x 2250	M 14974	2737	2737	3291	579	945	1845
4572 x 2000	I 1566	2606	2606	3097	522	853	1667
4572 x 2125	I 1570	2708	2708	3231	555	907	1770
4725 x 2000	I 15666	2716	2716	3160	540	882	1723
4725 x 2125	I 15670	2823	2823	3281	574	937	1830
4750 x 2000	M 15766	2687	2687	3187	543	887	1731
4750 x 2125	M 15770	2765	2765	3291	577	942	1840
4750 x 2250	M 15774	2820	2820	3383	611	997	1947
4877 x 2000	I 1666	2716	2716	3214	557	910	1778
4877 x 2125	I 1670	2823	2823	3344	593	967	1888
5000 x 2000	M 16566	2766	2766	3311	572	933	1822
5000 x 2125	M 16570	2823	2823	3399	608	992	1936
5000 x 2250	M 16574	2879	2879	3488	643	1050	2051
5000 x 2375	M 16579	2939	2939	3577	679	1108	2164
5000 x 2500	M 16582	2998	2998	3665	714	1167	2277
5500 x 2000	M 18166	2959	2959	3575	629	1027	2004
5500 x 2125	M 18170	3040	3040	3672	668	1090	2129
5500 x 2250	M 18174	3117	3117	3765	707	1156	2255

¹ Slategrain surface texture only available in standard RAL colours and Traffic White (RAL 9016).

² Silkgrain surface supplied with tension spring gear up to 3048 mm wide.

Prices in bold are generally a stock item. Non-bold prices require a longer lead-time.

I Imperial door sizes.

M Metric door sizes. Extended lead time of 4-6 weeks.

 Supplied as standard with tension spring gear. Torsion spring fitting available for Premium doors at £ 107 surcharge.

 Supplied as standard with torsion spring gear. Low headroom fitting available at £ 176 surcharge.

Purpose-made sizes available upon request. Non standard colours also available upon request. Doors supplied without locking as standard (see options on page 67 for handles). For window options please see page 49.

For Slategrain models, the door section has a Slategrain texture but the cover profiles and fascia are smooth.

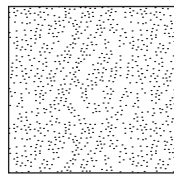
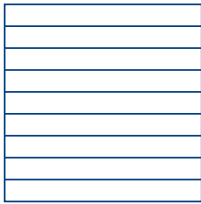
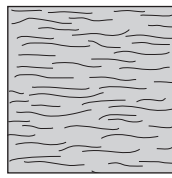
 Sandgrain ¹

 Timber Effect /
Titan (CH 703)

Linear medium design

 Brickwork
opening
Width x Height
(mm x mm)

 Size
Code



Premium



Premium

 Surcharge
for
Standard
Colours

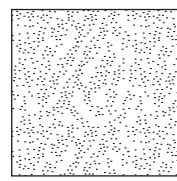
Brickwork opening Width x Height (mm x mm)	Size Code	Premium	Premium	Surcharge for Standard Colours
2080 x 2000	I 61066	1486	1885	238
2080 x 2080	I 610610	1546	1959 ³	248
2134 x 2000	I 7066	1486	1885 ²	245
2134 x 2125	I 7070	1546	1959 ²	260
2250 x 1900	M 7462	1579	2020	242
2250 x 2000	M 7466	1609	2057	258
2250 x 2125	M 7470	1615	2058	274
2286 x 2000	I 7666	1486	1885 ²	262
2286 x 2125	I 7670	1546	1959 ²	279
2286 x 2250	I 7674	1617	2051 ²	294
2286 x 2375	I 7679	1689	2142	310
2286 x 2500	I 7682	1752	2226	327
2375 x 1900	M 7962	1579	2020	255
2375 x 2000	M 7966	1585	2022	272
2375 x 2125	M 7970	1588	2025	288
2375 x 2250	M 7974	1650	2099	306
2438 x 2000	I 8066	1570	1999 ²	280
2438 x 2125	I 8070	1638	2083 ²	297
2438 x 2250	I 8074	1690	2144 ⁴	314
2438 x 2375	I 8079	1763	2246	332
2438 x 2500	I 8082	1844	2351	349
2500 x 1900	M 8262	1579	2020	269
2500 x 2000	M 8266	1585	2022	286
2500 x 2125	M 8270	1588	2025	304
2500 x 2250	M 8274	1650	2099	322
2500 x 2375	M 8279	1752	2237	340
2500 x 2500	M 8282	1755	2233	358
2500 x 2750	M 8290	-	-	394
2591 x 2000	I 8666	1570	1999	297
2591 x 2125	I 8670	1638	2083 ²	315
2625 x 2125	M 8770	1807	2325	319
2740 x 2000	I 9066	1712	2198	314
2740 x 2125	I 9070	1783	2283 ²	334
2750 x 2000	M 9166	1777	2286	315
2750 x 2125	M 9170	1847	2376	335
2750 x 2250	M 9174	1888	2429	354
2750 x 2375	M 9179	1954	2510	374
2750 x 2500	M 9182	2039	2624	394
2896 x 2000	I 9666	1800	2316	332
2896 x 2125	I 9670	1874	2407	352
3000 x 2000	M 91066	2015	3115	343
3000 x 2125	M 91070	2017	2611	365
3000 x 2250	M 91074	2037	2639	387
3000 x 2375	M 91079	2131	2758	408
3000 x 2500	M 91082	2222	2879	429
3000 x 3000	M 910910	2464	3489	515
3048 x 2000	I 1066	1800	2316	349
3048 x 2125	I 1070	1874	2407 ⁴	371
3250 x 2000	M 10866	2127	2770	372
3250 x 2125	M 10870	2188	2850	395
3250 x 2250	M 10874	2252	2929	418
3353 x 2000	I 1166	2142	2779	383
3353 x 2125	I 1170	2224	2892	408
3500 x 2000	M 11666	2258	2949	400
3500 x 2125	M 11670	2319	3028	426
3500 x 2250	M 11674	2389	3118	451
3658 x 2000	I 1266	2408	3144	418
3658 x 2125	I 1270	2503	3268 ⁴	445



Sandgrain ¹

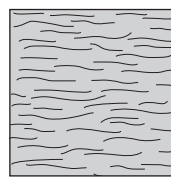

Timber Effect / Titan (CH 703)

Linear medium design

Brickwork opening
Width x Height
(mm x mm)

Size Code



Premium



Premium

Surcharge for Standard Colours

Brickwork opening Width x Height (mm x mm)	Size Code		Premium	Premium	Surcharge for Standard Colours
3750 x 2000	M	12466	2309	3018	429
3750 x 2125	M	12470	2383	3115	455
3750 x 2250	M	12474	2452	3210	483
3962 x 2000	I	1366	2478	3243	453
3962 x 2125	I	1370	2568	3366 ⁴	482
4000 x 2000	M	13266	2423	3178	457
4000 x 2125	M	13270	2484	3258	486
4000 x 2250	M	13274	2568	3363	515
4250 x 2000	M	131166	2524	3315	486
4250 x 2125	M	131170	2602	3419	517
4250 x 2250	M	131174	2679	3518	546
4267 x 2000	I	1466	2549	3339 ²	488
4267 x 2125	I	1470	2651	3477 ²	519
4420 x 2000	I	14666	2613	3428	506
4420 x 2125	I	14670	2719	3568 ²	537
4500 x 2000	M	14966	2650	3489	515
4500 x 2125	M	14970	2734	3597	546
4500 x 2250	M	14974	2794	3676	579
4572 x 2000	I	1566	2631	3452	522
4572 x 2125	I	1570	2745	3601	555
4725 x 2000	I	15666	2680	3524	540
4725 x 2125	I	15670	2787	3660 ⁴	574
4750 x 2000	M	15766	2703	3562	543
4750 x 2125	M	15770	2791	3679	577
4750 x 2250	M	15774	2870	3780	611
4877 x 2000	I	1666	2731	3586	557
4877 x 2125	I	1670	2836	3730 ²	593
5000 x 2000	M	16566	2806	3703	572
5000 x 2125	M	16570	2882	3801	608
5000 x 2250	M	16574	2953	3900	643
5000 x 2375	M	16579	3032	3999	679
5000 x 2500	M	16582	3103	4096	714
5500 x 2000	M	18166	3023	4002	629
5500 x 2125	M	18170	3105	4110	668
5500 x 2250	M	18174	3186	4215	707

¹ Sandgrain surface available in Traffic White (RAL 9016) and Anthracite Grey (RAL 7016).

² Available as stock door in Rosewood or Golden Oak timber effect.

³ Available as stock door in Rosewood timber effect.

⁴ Available as stock door in Golden Oak timber effect.

Prices in bold are generally a stock item. Non-bold prices require a longer lead-time.

I Imperial door sizes.

M Metric door sizes. Extended lead time of 4-6 weeks.

Supplied as standard with tension spring gear. Torsion spring fitting available for Premium doors at £ 107 surcharge.

Supplied as standard with torsion spring gear. Low headroom fitting available at £ 176 surcharge.



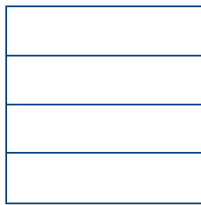

Purpose-made sizes available upon request. Non standard colours also available upon request. Doors supplied without locking as standard (see options on page 67 for handles). For window options please see page 49.





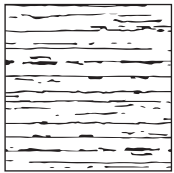
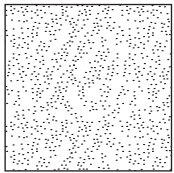
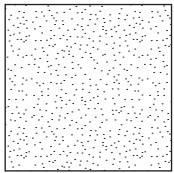
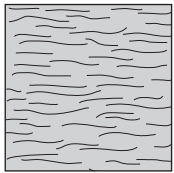

Linear large design

 Brickwork opening
Width x Height
(mm x mm)

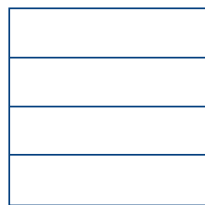
Size Code

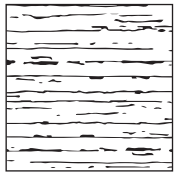
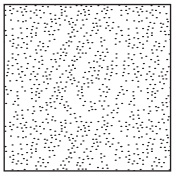
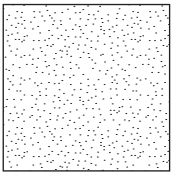
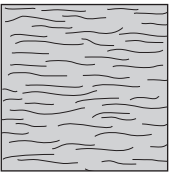
								
		Slategrain ¹	Sandgrain ²	Silkgrain ³	Timber Effect / Titan (CH 703)			
						Surcharge for Standard Colours	Surcharge for Non-Std. Colours	Surcharge for Special RAL
		Premium	Premium	Premium	Premium			
2080 x 2000	I 61066	1529	1731	1919	2107	238	390	759
2080 x 2080	I 610610	1586	1754	1943	2131	248	405	789
2134 x 2000	I 7066	1586	1731	1919	2107	245	399	778
2134 x 2125	I 7070	1641	1754	1943	2131	260	424	827
2250 x 1900	M 7462	1691	1828	2034	2237	242	395	768
2250 x 2000	M 7466	1737	1865	2070	2274	258	421	820
2250 x 2125	M 7470	1737	1866	2074	2276	274	447	872
2286 x 2000	I 7666	1586	1731	1919	2107	262	428	834
2286 x 2125	I 7670	1641	1754	1943	2131 ⁴	279	454	885
2286 x 2250	I 7674	1660	1827	2029	2227	294	481	938
2286 x 2375	I 7679	1794	1839	2037	2234	310	507	990
2286 x 2500	I 7682	1788	1888	2088	2289	327	535	1042
2375 x 1900	M 7962	1691	1828	2034	2237	255	417	812
2375 x 2000	M 7966	1687	1837	2040	2241	272	445	867
2375 x 2125	M 7970	1690	1841	2043	2242	288	471	921
2375 x 2250	M 7974	1717	1898	2103	2310	306	499	974
2438 x 2000	I 8066	1670	1828	2027	2228	280	455	889
2438 x 2125	I 8070	1736	1861	2069	2273 ⁵	297	484	944
2438 x 2250	I 8074	1746	1954	2169	2384	314	512	1000
2438 x 2375	I 8079	1883	2005	2225	2445	332	541	1055
2438 x 2500	I 8082	1875	2061	2286	2512	349	570	1111
2500 x 1900	M 8262	1691	1828	2034	2237	269	437	854
2500 x 2000	M 8266	1687	1837	2040	2241	286	467	911
2500 x 2125	M 8270	1690	1841	2043	2242	304	497	968
2500 x 2250	M 8274	1717	1898	2103	2310	322	525	1026
2500 x 2375	M 8279	1817	1988	2206	2422	340	555	1083
2500 x 2500	M 8282	1816	1991	2207	2421	358	583	1140
2500 x 2750	M 8290	2212	-	-	-	394	642	1253
2591 x 2000	I 8666	1670	1828	2027	2228	297	484	944
2591 x 2125	I 8670	1736	1861	2069	2273	315	515	1003
2625 x 2125	M 8770	1917	2115	2358	2598	319	521	1017
2740 x 2000	I 9066	1814	2006	2231	2458	314	512	999
2740 x 2125	I 9070	1877	2033	2263	2493	334	544	1062
2750 x 2000	M 9166	1945	2134	2379	2622	315	515	1002
2750 x 2125	M 9170	2008	2180	2429	2676	335	546	1066
2750 x 2250	M 9174	2015	2292	2553	2814	354	578	1128
2750 x 2375	M 9179	2066	2343	2612	2879	374	610	1191
2750 x 2500	M 9182	2165	2395	2674	2947	394	642	1253
2896 x 2000	I 9666	1898	2114	2356	2598	332	541	1055
2896 x 2125	I 9670	1977	2146	2390	2634	352	575	1122
3000 x 2000	M 91066	2191	2228	2487	2743	343	560	1093
3000 x 2125	M 91070	2186	2228	2484	2739	365	596	1162
3000 x 2250	M 91074	2205	2315	2583	2847	387	631	1231
3000 x 2375	M 91079	2261	2427	2711	2991	408	666	1298
3000 x 2500	M 91082	2356	2466	2749	3032	429	701	1367
3000 x 3000	M 910910	2870	3325	3725	4122	515	840	1640
3048 x 2000	I 1066	1833	2114	2356	2598	349	570	1111
3048 x 2125	I 1070	1899	2146	2390	2634	371	606	1180
3250 x 2000	M 10866	2207	2549	2853	3156	372	608	1185
3250 x 2125	M 10870	2267	2588	2898	3205	395	645	1258
3250 x 2250	M 10874	2316	2640	2953	3264	418	684	1333
3353 x 2000	I 1166	2172	2503	2803	3100	383	627	1222
3353 x 2125	I 1170	2259	2543	2845	3145	408	666	1298
3500 x 2000	M 11666	2357	2606	2919	3230	400	654	1276
3500 x 2125	M 11670	2417	2656	2976	3292	426	694	1356
3500 x 2250	M 11674	2466	2698	3024	3343	451	735	1435
3658 x 2000	I 1266	2564	2824	3169	3511	418	684	1333
3658 x 2125	I 1270	2665	2876	3227	3575	445	726	1416
3750 x 2000	M 12466	2495	2650	2971	3287	429	701	1367



								
		Slategrain ¹	Sandgrain ²	Silkgrain ³	Timber Effect / Titan (CH 703)			
Linear large design								
Brickwork opening Width x Height (mm x mm)		Premium	Premium	Premium	Premium	Surcharge for Standard Colours	Surcharge for Non-Std. Colours	Surcharge for Special RAL
Size Code								
M	12470	2563	2673	2994	3311	455	744	1453
M	12474	2619	2737	3065	3390	483	788	1539
I	1366	2661	2911	3270	3626	453	741	1443
I	1370	2763	2955	3317	3676	482	786	1534
M	13266	2629	2850	3197	3542	457	747	1458
M	13270	2708	2922	3282	3635	486	794	1549
M	13274	2763	2993	3358	3720	515	840	1640
M	131166	2777	3018	3388	3757	486	794	1549
M	131170	2860	3078	3458	3833	517	844	1645
M	131174	2921	3134	3522	3903	546	893	1742
I	1466	2764	2998	3370	3738	488	796	1556
I	1470	2875	3049	3426	3799 ⁶	519	847	1652
I	14666	2857	3081	3464	3843	506	825	1611
I	14670	2973	3132	3517	3902	537	876	1711
M	14966	2924	3075	3454	3831	515	840	1640
M	14970	3012	3173	3566	3956	546	893	1742
M	14974	3070	3244	3651	4049	579	945	1845
I	1566	2910	3116	3501	3886	522	853	1667
I	1570	3027	3166	3557	3947	555	907	1770
I	15666	3038	3169	3565	3958	540	882	1723
I	15670	3158	3225	3627	4027	574	937	1830
M	15766	3014	3206	3605	4000	543	887	1731
M	15770	3107	3281	3690	4095	577	942	1840
M	15774	3160	3357	3777	4190	611	997	1947
I	1666	2910	3229	3629	4030	557	910	1778
I	1670	3027	3284	3693	4101	593	967	1888
M	16566	3108	3328	3747	4160	572	933	1822
M	16570	3172	3398	3828	4249	608	992	1936
M	16574	3233	3476	3915	4344	643	1050	2051
M	16579	3295	3559	4005	4444	679	1108	2164
M	16582	3356	3648	4099	4548	714	1167	2277
M	18166	3330	3462	3897	4329	629	1027	2004
M	18170	3418	3529	3976	4416	668	1090	2129
M	18174	3503	3651	4113	4568	707	1156	2255

¹ Slategrain surface texture only available in standard RAL colours and Traffic White (RAL 9016).

² Sandgrain surface available in Traffic White (RAL 9016) and Anthracite Grey (RAL 7016).

³ Silkgrain surface supplied with tension spring gear up to 3048 mm wide.

⁴ Available as stock door in Rosewood or Titan.

⁵ Available as stock door in Golden Oak timber effect.

⁶ Available as stock door in Rosewood or Golden Oak timber effect.

Prices in bold are generally a stock item. Non-bold prices require a longer lead-time.

I Imperial door sizes.

M Metric door sizes. Extended lead time of 4-6 weeks.

 Supplied as standard with tension spring gear. Torsion spring fitting available for Premium doors at £ 107 surcharge.

 Supplied as standard with torsion spring gear. Low headroom fitting available at £ 176 surcharge.

Purpose-made sizes available upon request. Non standard colours also available upon request. Doors supplied without locking as standard (see options on page 67 for handles). For window options please see page 49.

For Slategrain models, the door section has a Slategrain texture but the cover profiles and fascia are smooth.

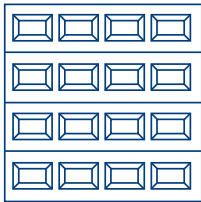

Woodgrain Premium (42 mm insulated)

Georgian design

Door width

Door Height	2000	2250	2375	2500	2750	3000	3250	3500	3750	4000	4250	4500	4750	5000	5250	5500
1900	1995	2003	2034	2217	2314	2604	2772	3030	3077	3138	3223	2261	2448	3448	3544	
2000	2015	2024	2052	2273	2445	2637	2834	3070	3136	3223	3309	3383	3451	3521	3618	
2080	2026	2037	2063	2304	2481	2653	2901	3105	3189	3309	3399	3470	3517	3592	3691	
2125	2026	2037	2063	2304	2481	2653	2901	3105	3189	3309	3399	3470	3517	3592	3691	
2205	2143	2165	2246	2349	2639	2682	2979	3178	3247	3393	3500	3550	3596	3671	3774	
2250	2057	2080	2156	2256	2532	2682	2979	3178	3247	3393	3500	3550	3596	3671	3774	
2375	2082	2118	2185	2301	2581	2752	3033	3244	3309	3448	3584	3644	3785	3864	3973	
2500	2123	2172	2221	2390	2675	2840	3087	3309	3374	3522	3632	3740	3971	4057	4172	
2600	2185	2230	2262	2483	2783	2934	3177	3377	3441	3609	3812	3926	4168	4260	4379	
2750	2351	2402	2412	2719	2961	3014	3229	3441	3590	3764	3977	4100	4355	4452	4577	
2850	2646	2704	2891	3138	3355	3397	3522	3587	3747	3929	4158	4279	4546	4649	-	
3000	2924	2970	3038	3223	3438	3478	3631	3735	3903	4095	4327	4453	4730	-	-	

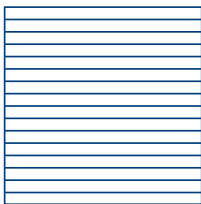

Woodgrain Premium (42 mm insulated)

Linear small design

Door width

Door Height	2000	2250	2375	2500	2750	3000	3250	3500	3750	4000	4250	4500	4750	5000	5250	5500
1900	1492	1539	1583	1772	1991	2117	2291	2298	2398	2501	2597	2687	2779	2930	3040	
2000	1547	1588	1632	1841	2052	2180	2362	2372	2467	2598	2693	2786	2858	3015	3130	
2080	1591	1630	1675	1890	2107	2241	2428	2449	2537	2674	2784	2880	2937	3098	3213	
2125	1591	1630	1675	1890	2107	2241	2428	2449	2537	2674	2784	2880	2937	3098	3213	
2205	1626	1667	1697	1911	2142	2300	2501	2519	2600	2756	2886	2955	3027	3195	3317	
2250	1626	1667	1697	1911	2142	2300	2501	2519	2600	2756	2886	2955	3027	3195	3317	
2375	1661	1705	1726	1955	2181	2356	2551	2589	2669	2833	2983	3069	3189	3362	3491	
2500	1691	1733	1766	2007	2223	2450	2633	2655	2737	2918	3043	3177	3344	3532	3662	
2600	1742	1787	1832	2108	2315	2543	2696	2737	2804	3001	3195	3332	3508	3704	3843	
2750	1911	1965	2021	2341	2576	2634	2770	2808	2923	3134	3334	3479	3663	3866	4011	
2850	2106	2156	2209	2438	2672	2723	2882	2931	3050	3267	3479	3633	3826	4035	-	
3000	2186	2253	2310	2533	2772	2812	2996	3047	3176	3400	3619	3781	3983	-	-	

Supplied with tensions spring as standard. Optional torsion spring available at additional cost, please see page 67.

These doors are only available with torsion spring.

For further options please see page 67.

Only fixed door heights are available on Georgian Premium sectional doors.

For intermediate heights, between designated heights in the table above please add £ 150 (for example, a required height of 2175 mm would be taken from the designated height 2205 mm).



Woodgrain Premium (42 mm insulated)

Linear medium design

Door width

Door Height	2000	2250	2375	2500	2750	3000	3250	3500	3750	4000	4250	4500	4750	5000	5250	5500
1900	1492	1539	1583	1773	1991	2117	2291	2298	2397	2501	2597	2687	2779	2930	3041	
2000	1546	1588	1630	1839	2050	2179	2360	2370	2466	2596	2692	2784	2857	3015	3129	
2080	1592	1629	1675	1890	2106	2241	2427	2450	2537	2673	2783	2879	2937	3098	3213	
2125	1592	1629	1675	1890	2106	2241	2427	2450	2537	2673	2783	2879	2937	3098	3213	
2205	1626	1666	1696	1910	2141	2300	2501	2519	2599	2755	2886	2954	3026	3195	3316	
2250	1626	1666	1696	1910	2141	2300	2501	2519	2599	2755	2886	2954	3026	3195	3316	
2375	1660	1704	1725	1954	2180	2355	2551	2589	2669	2832	2982	3069	3188	3362	3490	
2500	1689	1732	1766	2007	2221	2449	2631	2654	2736	2917	3042	3176	3343	3531	3661	
2600	1741	1787	1831	2106	2314	2542	2695	2736	2803	3000	3193	3331	3508	3702	3841	
2750	1910	1964	2020	2339	2575	2634	2769	2807	2924	3134	3333	3478	3663	3866	4011	
2850	2104	2155	2207	2436	2670	2722	2881	2928	3048	3266	3478	3632	3825	4034	-	
3000	2184	2251	2308	2531	2772	2811	2995	3045	3175	3400	3617	3779	3983	-	-	





Slategrain Premium (42 mm insulated)

Linear medium design

Door width

Door Height	2000	2250	2375	2500	2750	3000	3250	3500	3750	4000	4250	4500	4750	5000	5250	5500
1900	1492	1539	1583	1773	1991	2117	2291	2298	2397	2501	2597	2687	2779	2930	3041	
2000	1546	1588	1630	1839	2050	2179	2360	2370	2466	2596	2692	2784	2857	3015	3129	
2080	1592	1629	1675	1890	2106	2241	2427	2450	2537	2673	2783	2879	2937	3098	3213	
2125	1592	1629	1675	1890	2106	2241	2427	2450	2537	2673	2783	2879	2937	3098	3213	
2205	1626	1666	1696	1910	2141	2300	2501	2519	2599	2755	2886	2954	3026	3195	3316	
2250	1626	1666	1696	1910	2141	2300	2501	2519	2599	2755	2886	2954	3026	3195	3316	
2375	1660	1704	1725	1954	2180	2355	2551	2589	2669	2832	2982	3069	3188	3362	3490	
2500	1689	1732	1766	2007	2221	2449	2631	2654	2736	2917	3042	3176	3343	3531	3661	
2600	1741	1787	1831	2106	2314	2542	2695	2736	2803	3000	3193	3331	3508	3702	3841	
2750	1910	1964	2020	2339	2575	2634	2769	2807	2924	3134	3333	3478	3663	3866	4011	
2850	2104	2155	2207	2436	2670	2722	2881	2928	3048	3266	3478	3632	3825	4034	-	
3000	2184	2251	2308	2531	2772	2811	2995	3045	3175	3400	3617	3779	3983	-	-	

 Supplied with tensions spring as standard. Optional torsion spring available at additional cost, please see page 67.

 These doors are only available with torsion spring.

For further options please see page 67.

For intermediate heights, between designated heights in the table above please add £ 150 (for example, a required height of 2175 mm would be taken from the designated height 2205 mm).

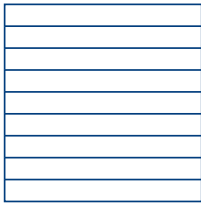

Sandgrain Premium (42 mm insulated)

Linear medium design

Door Height	Door width															
	2000	2250	2375	2500	2750	3000	3250	3500	3750	4000	4250	4500	4750	5000	5250	5500
1900	1529	1580	1624	1825	2053	2199	2375	2380	2486	2589	2684	2782	2877	2983	3095	
2000	1589	1635	1676	1898	2121	2263	2449	2460	2558	2693	2792	2884	2962	3070	3184	
2080	1641	1679	1724	1950	2174	2326	2519	3197	2629	2773	2882	2978	3042	3154	3270	
2125	1641	1679	1724	1950	2174	2326	2519	2538	2629	2773	2882	2978	3042	3154	3270	
2205	1701	1740	1769	2005	2241	2395	2591	2612	2699	2856	2991	3064	3139	3257	3380	
2250	1701	1740	1769	2005	2241	2395	2591	2612	2699	2856	2991	3064	3139	3257	3380	
2375	1756	1801	1837	2070	2302	2447	2647	2686	2770	2939	3092	3178	3300	3426	3555	
2500	1813	1856	1900	2164	2401	2546	2729	2757	2834	3022	3151	3290	3463	3598	3734	
2600	-	-	-	-	-	-	-	-	-	-	-	-	-	-	-	
2750	2108	2169	2228	2435	2658	2696	2862	2917	3316	3507	3616	3780	3868	4014	4172	
2850	-	-	-	-	-	-	-	-	-	-	-	-	-	-	-	
3000	2280	2349	2411	2641	2885	2923	3107	3167	3447	3695	3745	3912	4119	-	-	



Silkgrain Premium (42 mm insulated)

Linear medium design

Door Height	Door width															
	2000	2250	2375	2500	2750	3000	3250	3500	3750	4000	4250	4500	4750	5000	5250	5500
1900	1735	1799	1852	2089	2360	2532	2743	2749	2875	2995	3114	3225	3337	3463	3597	
2000	1805	1862	1910	2170	2436	2608	2830	2840	2957	3114	3233	3340	3434	3563	3701	
2080	1868	1911	1965	2229	2501	2679	2908	2930	3035	3207	3337	3451	3525	3659	3801	
2125	1868	1911	1965	2229	2501	2679	2908	2930	3035	3207	3337	3451	3525	3659	3801	
2205	1934	1981	2014	2294	2575	2760	2992	3013	3118	3300	3463	3550	3639	3777	3923	
2250	1934	1981	2014	2294	2575	2760	2992	3013	3118	3300	3463	3550	3639	3777	3923	
2375	1997	2052	2091	2370	2645	2816	3057	3101	3195	3399	3581	3683	3828	3976	4128	
2500	2062	2115	2165	2476	2758	2929	3148	3181	3277	3495	3649	3811	4015	4177	-	
2600	-	-	-	-	-	-	-	-	-	-	-	-	-	-	-	
2750	2404	2476	2545	2793	3061	3102	3303	3363	3835	4059	4196	4392	-	-	-	
2850	-	-	-	-	-	-	-	-	-	-	-	-	-	-	-	
3000	2607	2685	2760	3030	3319	3367	3586	3654	3990	4283	-	-	-	-	-	

■ Supplied with tensions spring as standard. Optional torsion spring available at additional cost, please see page 67.

□ These doors are only available with torsion spring.

For further options please see page 67.

For intermediate heights, between designated heights in the table above please add £ 150 (for example, a required height of 2175 mm would be taken from the designated height 2205 mm). Sandgrain doors are only available in the following colours: Anthracite Grey (RAL 7016) and Traffic White (RAL 9016). Cost for Sandgrain coloured doors is £ 61 per m². Other colours and RAL to choose are not possible.

For Linear Medium (Silkgrain) models, price available on request for door sizes 4750 mm to 5000 mm width and 2600 mm to 2850 mm height.

For Linear Medium (Silkgrain) models, price available on request for door sizes 5000 mm to 5500 mm width and 2600 mm to 2750 mm height.

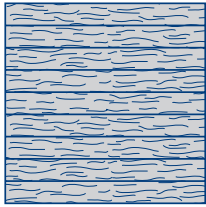

Timber Effect / Titan (CH 703) Premium (42 mm insulated)

Linear medium design

Door Height	Door width															
	2000	2250	2375	2500	2750	3000	3250	3500	3750	4000	4250	4500	4750	5000	5250	5500
1900	1909	1981	2040	2308	2614	2808	3047	3053	3195	3331	3465	3590	3717	3859	4011	
2000	1982	2048	2101	2395	2695	2889	3140	3151	3285	3462	3595	3718	3823	3968	4124	
2080	2052	2101	2162	2461	2769	2969	3228	3252	3372	3565	3713	3842	3925	4076	4237	
2125	2052	2101	2162	2461	2769	2969	3228	3252	3372	3565	3713	3842	3925	4076	4237	
2205	2126	2179	2214	2531	2848	3058	3319	3344	3462	3668	3852	3949	4051	4207	4372	
2250	2126	2179	2214	2531	2848	3058	3319	3344	3462	3668	3852	3949	4051	4207	4372	
2375	2194	2256	2301	2615	2926	3119	3391	3442	3547	3778	3984	4099	4263	4430	4601	
2500	2267	2327	2382	2734	3052	3245	3493	3530	3639	3884	4059	4242	4473	4654	4837	
2600	2637	2719	2796	3077	3380	3427	3652	3721	4254	4507	4662	4882	4998	5193	5401	
2750	2648	2730	2807	3088	3391	3438	3663	3732	4265	4518	4673	4893	5009	5204	5412	
2850	2860	2948	3033	3338	3664	3718	3966	4044	4422	4752	4821	5044	5320	-	-	
3000	2873	2961	3046	3351	3677	3731	3979	4057	4435	4765	4834	5057	5333	-	-	

Supplied with tension spring as standard. Optional torsion spring available at additional cost, please see page 67.

These doors are only available with torsion spring.

For further options please see page 67.

For intermediate heights, between designated heights in the table above please add £ 150 (for example, a required height of 2175 mm would be taken from the designated height 2205 mm).

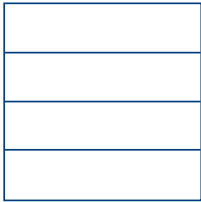

Woodgrain Premium (42 mm insulated)

Linear large design

Door Height	Door width															
	2000	2250	2375	2500	2750	3000	3250	3500	3750	4000	4250	4500	4750	5000	5250	5500
1900	1811	1874	1930	2177	2457	2619	2847	2855	2984	3115	3238	3358	3477	3675	3815	
2000	1877	1931	1982	2254	2530	2696	2930	2945	3068	3237	3358	3478	3571	3773	3921	
2080	1933	1982	2036	2317	2602	2770	3014	3038	3152	3333	3470	3596	3675	3878	4030	
2125	1933	1982	2036	2317	2602	2770	3014	3038	3152	3333	3470	3596	3675	3878	4030	
2205	1972	2023	2063	2341	2629	2846	3100	3129	3232	3431	3600	3692	3782	4000	4162	
2250	1972	2023	2063	2341	2629	2846	3100	3129	3232	3431	3600	3692	3782	4000	4162	
2375	2016	2065	2094	2390	2681	2911	3163	3213	3317	3526	3720	3834	3990	4211	4378	
2500	2045	2103	2148	2457	2733	3028	3266	3297	3398	3631	3797	3969	4189	4425	4597	
2600	2104	2168	2225	2577	2849	3144	3336	3396	3479	3738	3985	4162	4392	4645	4823	
2750	2319	2391	2462	2878	3182	3258	3431	3483	3633	3903	4161	4352	4592	4852	5040	
2850	2569	2635	2702	2996	3303	3363	3570	3633	3789	4068	4345	4544	4795	5068	-	
3000	2667	2753	2830	3118	3427	3479	3714	3781	3946	4241	4521	4729	4994	-	-	

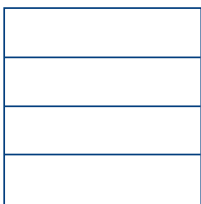

Slategrain Premium (42 mm insulated)

Linear large design

Door Height	Door width															
	2000	2250	2375	2500	2750	3000	3250	3500	3750	4000	4250	4500	4750	5000	5250	5500
1900	1811	1874	1930	2177	2457	2619	2847	2855	2984	3115	3238	3358	3477	3675	3815	
2000	1877	1931	1982	2254	2530	2696	2930	2945	3068	3237	3358	3478	3571	3773	3921	
2080	1933	1982	2036	2317	2602	2770	3014	3038	3152	3333	3470	3596	3675	3878	4030	
2125	1933	1982	2036	2317	2602	2770	3014	3038	3152	3333	3470	3596	3675	3878	4030	
2205	1972	2023	2063	2341	2629	2846	3100	3129	3232	3431	3600	3692	3782	4000	4162	
2250	1972	2023	2063	2341	2629	2846	3100	3129	3232	3431	3600	3692	3782	4000	4162	
2375	2016	2065	2094	2390	2681	2911	3163	3213	3317	3526	3720	3834	3990	4211	4378	
2500	2045	2103	2148	2457	2733	3028	3266	3297	3398	3631	3797	3969	4189	4425	4597	
2600	2104	2168	2225	2577	2849	3144	3336	3396	3479	3738	3985	4162	4392	4645	4823	
2750	2319	2391	2462	2878	3182	3258	3431	3483	3633	3903	4161	4352	4592	4852	5040	
2850	2569	2635	2702	2996	3303	3363	3570	3633	3789	4068	4345	4544	4795	5068	-	
3000	2667	2753	2830	3118	3427	3479	3714	3781	3946	4241	4521	4729	4994	-	-	

Supplied with tension spring as standard. Optional torsion spring available at additional cost, please see page 67.

These doors are only available with torsion spring.

For further options please see page 67.

For intermediate heights, between designated heights in the table above please add £ 150 (for example, a required height of 2175 mm would be taken from the designated height 2205 mm).

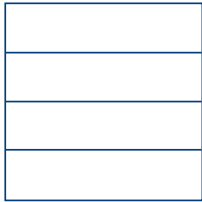

Sandgrain Premium (42 mm insulated)

Linear large design

Door Height	Door width															
	2000	2250	2375	2500	2750	3000	3250	3500	3750	4000	4250	4500	4750	5000	5250	5500
1900	1923	1934	1944	2140	2346	2540	2611	2648	2665	2831	2917	2989	3014	3067	3127	
2000	1955	1957	1971	2197	2429	2628	2690	2738	2868	2940	3013	3175	3202	3258	3320	
2080	1978	1982	1987	2247	2470	2674	2744	2757	2925	3022	3114	3226	3281	3338	3404	
2125	1978	1982	1987	2247	2470	2674	2744	2757	2925	3022	3114	3226	3281	3338	3404	
2205	2018	2034	2063	2362	2597	2725	2786	2828	3011	3094	3202	3304	3354	3414	3480	
2250	2018	2034	2063	2362	2597	2725	2786	2828	3011	3094	3202	3304	3354	3414	3480	
2375	2033	2050	2106	2414	2620	2777	2844	2925	3090	3173	3291	3426	3528	3595	3665	
2500	2046	2089	2155	2469	2658	2818	2888	2972	3151	3247	3385	3512	3706	3772	3847	
2600	2191	2239	2321	2714	2874	2960	3017	3129	3349	3471	3695	3836	4050	4123	4208	
2750	2202	2250	2332	2725	2885	2971	3028	3140	3360	3482	3706	3847	4061	4134	4219	
2850	2639	2695	2727	2998	3153	3235	3296	3395	3631	3770	4014	4166	4402	-	-	
3000	2652	2708	2740	3011	3166	3248	3309	3408	3644	3783	4027	4179	4415	-	-	

 Supplied with tension spring as standard. Optional torsion spring available at additional cost, please see page 67.

 These doors are only available with torsion spring.

For further options please see page 67.

For intermediate heights, between designated heights in the table above please add £ 150 (for example, a required height of 2175 mm would be taken from the designated height 2205 mm).

Heights between 2505 mm - 2570 mm and 2755 mm - 2870 mm are not available in Sandgrain. Sandgrain doors are only available in the following colours: Anthracite Grey (RAL 7016) and Traffic White (RAL 9016). Cost for Sandgrain coloured doors is £ 61 per m². Other colours and RAL to choose are not possible.

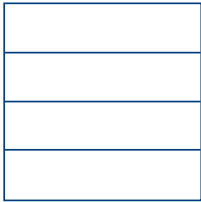

Silkgrain Premium (42 mm insulated)

Linear large design

Door Height	Door width															
	2000	2250	2375	2500	2750	3000	3250	3500	3750	4000	4250	4500	4750	5000	5250	5500
1900	2134	2147	2158	2384	2616	2838	2918	2959	2979	3168	3266	3346	3376	3437	3502	
2000	2166	2170	2185	2445	2708	2933	3003	3058	3206	3288	3372	3555	3586	3652	3721	
2080	2190	2195	2201	2498	2753	2980	3061	3080	3267	3379	3486	3608	3671	3741	3816	
2125	2190	2195	2201	2498	2753	2980	3061	3080	3267	3379	3486	3608	3671	3741	3816	
2205	2233	2253	2284	2625	2895	3038	3107	3155	3365	3456	3582	3696	3757	3828	3901	
2250	2233	2253	2284	2625	2895	3038	3107	3155	3365	3456	3582	3696	3757	3828	3901	
2375	2249	2272	2331	2684	2919	3093	3173	3262	3455	3548	3684	3835	3958	4029	4109	
2500	2263	2310	2389	2746	2963	3139	3220	3318	3521	3630	3789	3933	4151	4225	-	
2600	2426	2482	2572	3021	3199	3299	3365	3491	3740	3882	4140	4297	-	-	-	
2750	2437	2493	2583	3032	3210	3310	3376	3502	3751	3893	4151	4308	-	-	-	
2850	2930	2992	3032	3338	3517	3610	3679	3793	4063	4219	4495	-	-	-	-	
3000	2943	3005	3045	3351	3530	3623	3692	3806	4076	4232	4508	-	-	-	-	

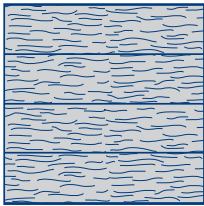

Timber Effect / Titan (CH 703) Premium (42 mm insulated)

Linear large design

Door Height	Door width															
	2000	2250	2375	2500	2750	3000	3250	3500	3750	4000	4250	4500	4750	5000	5250	5500
1900	2323	2337	2350	2600	2857	3103	3192	3238	3260	3469	3578	3667	3700	3768	3839	
2000	2356	2361	2378	2666	2957	3207	3285	3346	3509	3601	3693	3897	3930	4004	4081	
2080	2381	2387	2394	2722	3006	3258	3347	3368	3575	3700	3818	3954	4023	4101	4184	
2125	2381	2387	2394	2722	3006	3258	3347	3368	3575	3700	3818	3954	4023	4101	4184	
2205	2427	2450	2483	2862	3161	3320	3396	3450	3683	3783	3923	4050	4117	4195	4277	
2250	2427	2450	2483	2862	3161	3320	3396	3450	3683	3783	3923	4050	4117	4195	4277	
2375	2443	2469	2535	2925	3186	3379	3469	3567	3780	3884	4034	4203	4338	4417	4507	
2500	2457	2510	2597	2993	3234	3429	3519	3628	3852	3974	4150	4310	4551	4634	4731	
2600	2636	2699	2798	3296	3494	3604	3678	3817	4093	4250	4537	4711	4982	5074	5180	
2750	2647	2710	2809	3307	3505	3615	3689	3828	4104	4261	4548	4722	4993	5085	5191	
2850	3192	3261	3305	3645	3843	3946	4023	4149	4449	4622	4928	5124	5418	-	-	
3000	3205	3274	3318	3658	3856	3959	4036	4162	4462	4635	4941	5137	5431	-	-	

■ Supplied with tension spring as standard. Optional torsion spring available at additional cost, please see page 67.

□ These doors are only available with torsion spring.

For further options please see page 67.

For intermediate heights, between designated heights in the table above please add £ 150 (for example, a required height of 2175 mm would be taken from the designated height 2205 mm). Please note, heights between 2505 mm - 2570 mm and 2755 mm - 2870 mm are not available in Silkgrain, Timber Effect and Titan (CH 703) doors.

For Linear Medium (Silkgrain) models, price available on request for door sizes 4750 mm to 5000 mm width and 2600 mm to 2850 mm height.

For Linear Medium (Silkgrain) models, price available on request for door sizes 5000 mm to 5500 mm width and 2600 mm to 2750 mm height.

Options for sectional doors

add

Special anchor set (required if you fix the door between brickwork and fasten the frame on the side).
If using special anchor set 90 mm cover profiles will be required to cover fixing holes. Two anchor sets are required for doors over 2250mm high.

77

Please note: Frame legs for brown and any coloured doors come in white as standard, matching cover profiles are available. Silkgrain, Foil Coated Timber Effect and Titan Metallic (CH 703) are available ex-stock. Please however note Colours and RAL to choose must be ordered with the door and cannot be ordered as a spare part at a later time.

Cover Profiles

Door height	White				Standard Colour				RAL to choose				Special RAL				Foil Coated Timber Effect / Titan (CH 703)	
	Woodgrain		Sandgrain/ Silkgrain/ Slategrain		Woodgrain		Sandgrain/ Silkgrain/ Slategrain (Smooth)		Woodgrain		Silkgrain (Smooth)		Woodgrain		Silkgrain		55	90
1875	83	116	87	127	97	145	118	152	139	205	145	222	154	242	161	258	130	162
2000	88	124	94	135	102	155	126	161	149	218	155	235	163	258	172	275	137	172
2125	95	132	100	143	108	164	135	172	158	232	164	251	173	273	182	291	145	183
2250	100	139	105	153	115	174	142	182	167	246	174	265	185	289	193	309	155	194
2375	105	146	110	160	122	185	151	192	176	260	185	281	193	305	204	325	163	205
2500	110	155	116	169	127	193	158	201	186	273	193	295	204	321	215	343	171	215
For door heights not specified above, use formula: door height x price below (i.e. door height 2600 for "White Woodgrain 55": 2.6 x 44 = £ 114,4)																		
	44	61	47	66	51	76	62	79	73	108	76	117	82	128	86	138	68	86

Purpose-made width cut-down service (check for size limitations).	110
Purpose-made height cut-down service (check for size limitations).	150
Classic black handle set and lock for on-site installation	88
White finish cast aluminium handle set and lock for on-site installation	241
Brushed stainless steel finish cast aluminium handle set and lock for on-site installation	241
Factory cut hole for handle and lock available with a 2 week increase in lead-time (complete with classic black handle as standard) ¹	134
Standard headroom torsion spring for sectional door less than 4000 mm wide ²	107
Low headroom tracks arrangement for torsion spring door over 4000 mm wide (when purchased with door) ²	174

¹ Please note: Only available for stock doors (highlighted in bold) on pages 50 - 59.

² Excluding Silkgrain. For Silkgrain surface finish, torsion spring gear can only be supplied on doors over 3050 mm wide.

ThermoFrame set

ThermoFrame set 4

RM height	up to 3000 mm	3x plastic angle profiles	Length 3210 mm	per set	434
LZ width	up to 3210 mm				

ThermoFrame set 5

RM height	up to 3000 mm	2x plastic angle profiles	Length 3210 mm	per set	434
LZ width	from 3210 mm up to 6000 mm	1x plastic angle profile	Length 6000 mm		

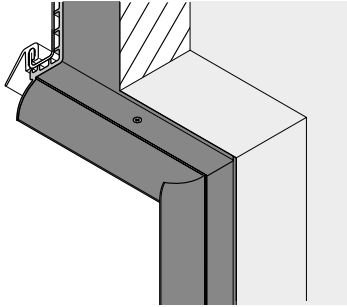

Set consists of

- 3x Plastic angle profiles black 84 x 22.5 mm with lip seal

Note on set 4 and 5 (frame covering not possible):

- A single-skinned fascia panel is fitted. Required headroom corresponds with track application Z, N and L.
- Please also note the supplements and limitations in the technical manual!

Options for purpose-made sectional doors

Standard colour finish for purpose made sectional doors (i.e. 2000 mm x 2125 mm is an area of 4.25 m ²)	per m ²	58
RAL to choose or CH 703 colour finish for purpose made sectional doors	per m ²	93
Special colour finish for purpose made sectional doors	per m ²	183
Top fascia for sectional doors (95 mm). Woodgrain surface texture (Traffic White RAL 9016)	per m	44
Top fascia for sectional doors (95 mm). Sandgrain surface texture (Traffic White RAL 9016)	per m	49
Top fascia for sectional doors (95 mm). Silkgrain surface texture (Traffic White RAL 9016)	per m	49
Top fascia for sectional doors (95 mm). Timber Effect surface texture (Timber Effect and CH 703)	per m	70
Top fascia for sectional doors (95 mm). Standard colour finish	per m ²	58
Top fascia for sectional doors (95 mm). RAL to choose or CH 703	per m ²	95
Top fascia for sectional doors (95 mm). Special RAL colours	per m ²	183

Sectional doors up to 4000 mm wide and/ or 2500 mm high (excluding Silkgrain surface finish) and
 Sectional doors up to 3048 mm wide and/ or 2500 mm high (with Silkgrain surface finish):

These doors come with tension spring fitting. With doors from the Premium range the tension springs can be replaced by torsion springs as an option. Tension springs are suitable for low headroom installations. For a low headroom installation with torsion springs please order low headroom track set separately (changing to a low headroom option is not available as a retrofit).

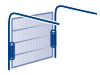

**Sectional garage door
 with tension spring fitting**

Minimum garage dimensions for manually operated doors

Headroom:	100 mm
Sideroom:	90 mm (each side)
Depth into garage:	garage door height + 510 mm
Clear passage height for manually operated doors:	garage door height – 80 mm

Minimum garage dimensions for doors with GaraMatic operator

Headroom	115 mm
Sideroom:	90 mm (each side)
Depth into garage:	for doors up to 2125 mm high: 3200 mm for doors up to 2500 mm high: 3450 mm for doors up to 3000 mm high: 4125 mm

Clear passage height for doors with GaraMatic operator:	garage door height – 30 mm
---	----------------------------

Minimum ceiling height:	115 mm
Minimum ceiling height (with ThermoFrame):	145 mm

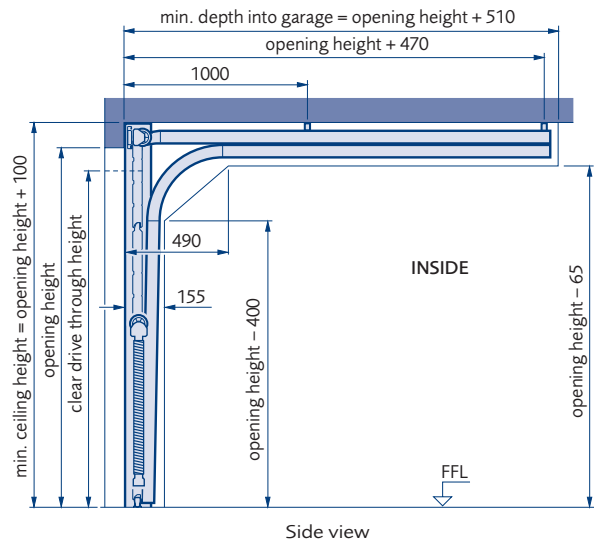

Side view

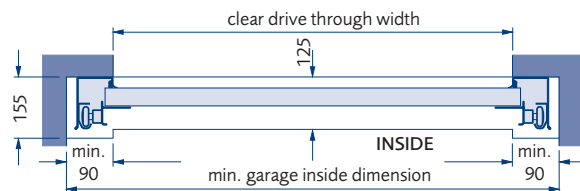

Plan view

Sectional doors with torsion spring fitting wider than 4000 mm wide (excluding Silkgrain surface finish) and
 Sectional doors wider than 3048 mm wide (with Silkgrain surface finish):

These doors come with torsion springs as standard. For a low headroom installation with torsion springs please order low headroom track pack (changing to a low headroom option is not available as a retrofit).



**Sectional garage door
 with torsion spring fitting**

Minimum garage dimensions for manually operated doors

Headroom:	210 mm
Sideroom:	90 mm (each side)
Depth into garage:	garage door height + 510 mm
Clear passage height for manually operated doors:	garage door height – 50 mm

Minimum garage dimensions for doors with GaraMatic operator

Headroom:	210 mm
Sideroom:	90 mm (each side)
Depth into garage:	for doors up to 2125 mm high: 3200 mm for doors up to 2500 mm high: 3450 mm for doors up to 3000 mm high: 4125 mm

Clear passage height
for doors with
GaraMatic operator: full garage door height

Minimum ceiling height:	210 mm
Minimum ceiling height (with ThermoFrame):	255 mm

Excludes Silkgrain surface finish.
 Torsion spring available for doors over 3000 mm x 2250 mm

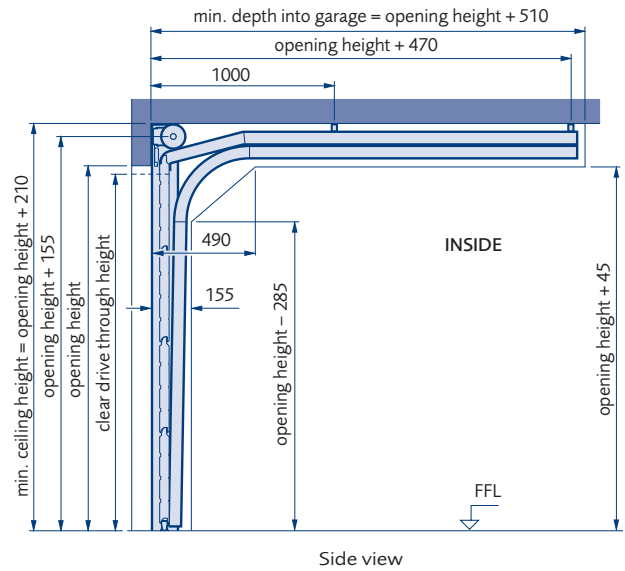

Side view

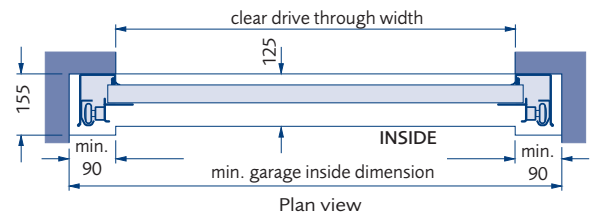

Plan view

Sectional doors with low-headroom torsion spring fitting wider than 4000 mm wide (excluding Silkgrain surface finish) and Sectional doors wider than 3048 mm wide (with Silkgrain surface finish):

These doors come with torsion springs as standard. For a low headroom installation with torsion springs please order low headroom track pack (changing to a low headroom option is not available as a retrofit).

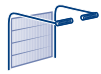

Sectional garage door with low headroom torsion spring fitting

Minimum garage dimensions for manually operated doors

Headroom:	100 mm
Sideroom:	90 mm (each side)
Depth into garage:	garage door height + 510 mm
Clear passage height for manually operated doors:	garage door height – 100 mm

Minimum garage dimensions for doors with GaraMatic operator

Headroom:	115 mm
Sideroom:	90 mm (each side)
Depth into garage:	for doors up to 2125 mm high: 3200 mm for doors up to 3000 mm high: 4125 mm
Clear passage height for doors with GaraMatic operator:	for doors up to 3000 mm wide: garage door height – 30 mm for doors wider than 3000 mm: garage door height – 80 mm

Minimum ceiling height: 115 mm

Minimum ceiling height (with ThermoFrame): 145 mm

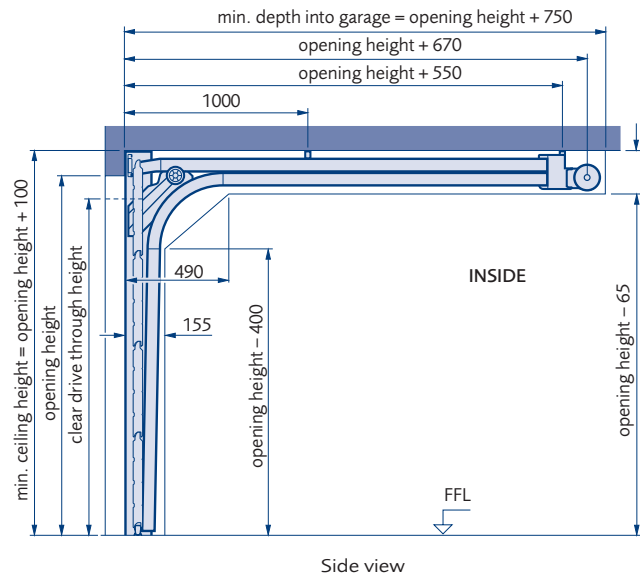

Side view

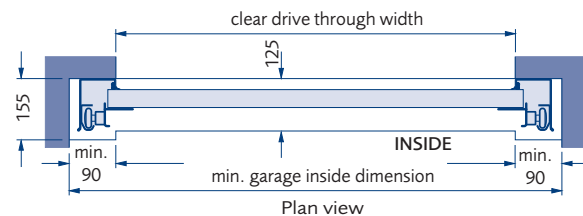

Plan view

Automation and Accessories

Operators

GaraMatic operators are an ideal match for all current Garador up & over and sectional garage doors. They are a tried and tested hardware combination, designed for use with Garador up & over or sectional garage doors, and prepared for easy installation. They feature energy efficient LED light, a power saving mode and a mechanical lock, built into the operator boom, to prevent forced lifting of the door.

What's Included

All GaraMatic operators come as a complete set, including operator head, boom and two 4-button hand transmitters.



BlueSecur App

The Garador BlueSecur app allows you to control your Series 4 GaraMatic operator from your android or ios smartphone. It allows you to operate the open/close, partial opening and integral light functions.



Both the GaraMatic 10 and GaraMatic 20 are supplied complete with an integrated bluetooth receiver, for control via Garador's BlueSecur smartphone app for android and ios devices. One free user key is included. Others available via in-app purchase. Please refer to Garador BlueSecur for pricing. The bluetooth receiver can be switched on and off. An optional bluetooth receiver is available as an add-on for the GaraMatic 9.



BS EN 13241 Compliant





The combination of Garador garage doors with GaraMatic operators complies with the latest European safety standards.



Operators





Operators	GaraMatic 9	GaraMatic 10	GaraMatic 20
			
	<p>Peak forces 750 N</p> <ul style="list-style-type: none"> • Simple to operate • Soft start and stop • Max. opening speed 20 cm/s • Automatic safety reversal • Integral LED light with 10 LEDs • Low power consumption (less than 1 w in stand by mode) • Supplied with two 4-button hand transmitters (black end caps) 	<p>Peak forces 800 N</p> <ul style="list-style-type: none"> • Control element with 2x 7-segment display • Soft start and stop • Max. opening speed 25 cm/s • Automatic safety reversal • Adjustable integral LED light with 20 LEDs • Partial opening function • Self-closing timer option • Integrated bluetooth receiver • HCP interface to connect smarhome systems • Low power consumption (less than 1 w in stand by mode) • Supplied with two 4-button hand transmitters (chrome end caps) • BlueSecur App: One free user key included. Others available via in-app purchase 	<p>Peak forces 1000 N</p> <ul style="list-style-type: none"> • Control element with 2x 7-segment display • Soft start and stop • Max. opening speed 25 cm/s • Automatic safety reversal • Adjustable integral LED light with 30 LEDs • Partial opening function • Self-closing timer option • Integrated bluetooth receiver • HCP interface to connect smarhome systems • Low power consumption (less than 1 w in stand by mode) • Supplied with two 4-button hand transmitters (chrome end caps) • BlueSecur App: One free user key included. Others available via in-app purchase
Canopy Doors ¹	640	805	859
Standard short boom ² Retractable and Sectional Doors up to 2125 mm high	524	647	719
Medium boom ²	559	682	754
Long boom ²	671	794	866



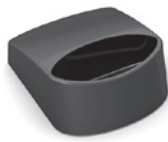

¹ Canopy door price includes bow arm system. GaraMatic 9 supplied with two 2-channel hand transmitters.





² For exact boom requirements see grid on page 77.





Accessories				
Article	Hand transmitter 5-channel (Bi-directional) in matt black	Hand transmitter 4-channel (Bi-directional) in matt black	Hand transmitter 4-channel (Bi-directional) in matt black (chrome caps)	Hand transmitter 5-channel (Bi-directional) in white
Reference No.	7471	7470	6809	6713
Price £	86	66	73	86

Accessories				
Article	Hand transmitter 5-channel (Bi-directional) in black	Hand transmitter 1-channel (Bi-directional) in black	Hand transmitter 4-channel (Bi-directional) in black	Hand transmitter station in black
Reference No.	6714	6710	6779	6719
Price £	86	73	73	13

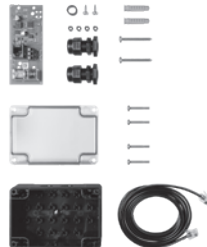

Accessories				
Article	Hand transmitter station in white	Hand transmitter sun visor/ wall holder	1-channel (Bi-directional) transmitter for car cigarette lighter	2-channel (Bi-directional) transmitter for car cigarette lighter
Reference No.	6720	6784	6782	6783
Price £	13	12	66	66

Accessories				
Article	Hand transmitter 2-channel (Bi-directional) Green	Robust 3-channel (Bi-directional) hand transmitter	IT3 B Wired Wall Console	FIT 2 Bi-directional wireless wall console
Reference No.	6965	8880	8733	6718
Price £	101	104	50	108

Accessories				
Article	IT1 B Wired illuminated push button	Series 4 External Bluetooth Antenna to increase signal range	IT1-1 Internal Push Button	FCT 3 BS Radio code switch
Reference No.	2875	8128	695	6717
Price £	41	103	31	129

Accessories				
Article	FCT 10 Wireless Code Switch (flip lid) 868 MHz bi-directional	Series 4 External Bluetooth receiver (GaraMatic 9 add-on)	Options relay for control of garage light, warning light or limit switch report HOR-HCP	Series 4 Universal Adapter Print for control of operator light, partial open and venti- lation position UAP-1-HCP
Reference No.	6716	8129	8125	8421
Price £	193	166	64	113

Accessories

			
Article	EL301N External light beam device	Emergency Battery Backup HNA 18-4 (for Series 4 operators)	EL101 Internal light beam device
Reference No.	2884	8126	6786
Price £	155	255	95

Additional options

De-latching kit Reference No. 705 for up & over doors, Garador single door range (437.195) (required to maintain mechanical locking system retractable doors only)	68
De-latching kit Reference No. 2643 for up & over doors, Garador double door range (437.197) (required to maintain mechanical locking system retractable doors only)	112
Emergency release Reference No. 704 for retractable up & over doors only (required if door is electrically operated and has no other personal access)	45
Emergency release Reference No. 703 for sectional door without handle and lock, or canopy up & over doors (required if door is electrically operated and has no other personal access)	63
Emergency release Reference No. 702 for sectional door with handle and lock (required if door is electrically operated and has no other personal access)	64
Lintel extension bracket Reference No. 709 for canopy doors (required if door is fitted between brickwork under the lintel)	63

Operator Specifications

Boom for canopy door including canopy bow arm

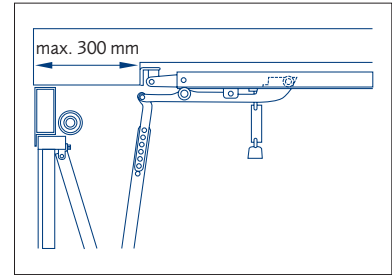
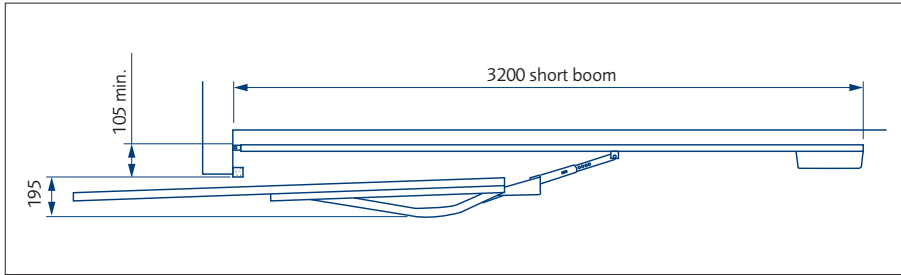

On horizontal doors the bow arm is to be fitted off centre.

Lintel extension bracket required for canopy doors fitted between the brickwork and under the lintel head.

Boom for retractable door

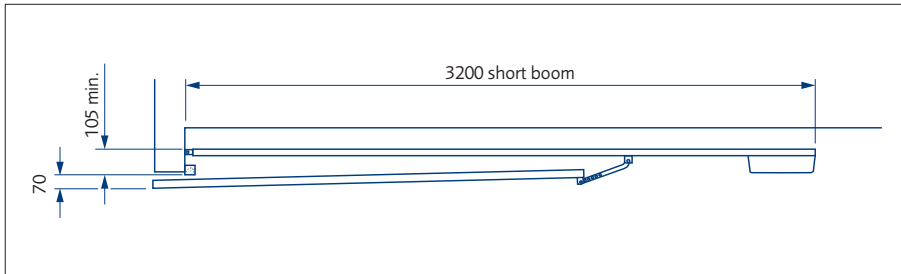

Boom for sectional door

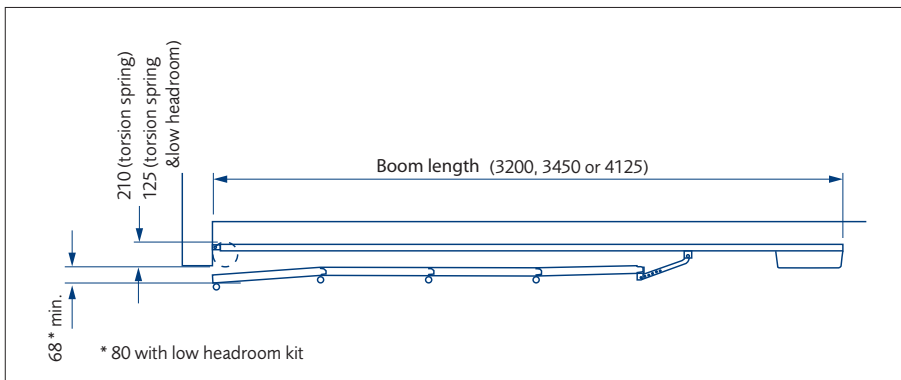

Maximum Door Height to suit Operator Booms

	Torsion Spring	Tension and Low Headroom Spring	Travel distance
Short Boom	2250 mm	2125 mm	2475 mm
Medium Boom	2500 mm	2375 mm	2725 mm
Long Boom	3000 mm	3000 mm	3400 mm

GaraRoll Roller Doors

GaraRoll Insulated Roller Doors

Spring-compensated, automated roller garage door for domestic applications only. All doors are made to suit the opening with the actual door size relating to the structural opening width x height and the guides fitting on the reveals to maintain a full opening size. The GaraRoll is the only roller garage door to include the cover hood, which the curtain rolls into at the head of the garage door opening, as standard. The door is also supplied complete with a DuraBelt anti-scratch system, designed to provide a protective layer between each lath as they roll up when the door is open.

Door curtain

77 mm rolled aluminium profile filled with 100 % CFC-free polyurethane rigid foam. Each lath is 15mm thick. Integrated windlocks fitted as standard.

Surface

Colour finish with double layer coil coating quality paint system or foil-coated timber effect finish.

Frame

Aluminium extrusion profile side guides with integrated plastic runners. Lintel and cover box made of steel. Colour of side guides and lintels supplied to match the door as standard. Except on foil-coated and deco paint timber effect doors where they are supplied in a solid brown paint finish. Cover box coated Grey White (RAL 9002).

Counterbalance

Tension spring technology with lateral integral double tension springs and double cables encased within a transparent cover.

Colours

Same colour inside and outside

- | | | | |
|--------------------------|------------------------------|--------------------------|------------------------------|
| - Light Ivory (RAL 1015) | - Moss Green (RAL 6005) | - Terra Brown (RAL 8028) | - White Aluminium (RAL 9006) |
| - Ruby Red (RAL 3003) | - Slate Grey (RAL 7015) | - Cream (RAL 9001) | - Grey Aluminium (RAL 9007) |
| - Purple Red (RAL 3004) | - Anthracite Grey (RAL 7016) | - Jet Black (RAL 9005) | - Traffic White (RAL 9016) |
| - Steel Blue (RAL 5011) | - Light Grey (RAL 7035) | - Chartwell Green | |

Deco paint doors available in Anthracite Metallic (Noir 2100 Sable), Golden Oak and Rosewood, with the same finish inside and out.

Foil-coated doors available in Golden Oak and Rosewood, with the inside of the lath in dark brown (foil coat not available on GaraRoll external roller garage door).

Operator and Control

Garador operator and control included. 24 V DC gear drive, mains voltage 230-240 V AC, 0.5 kW, opening speed approx. 11 cm/s, integrated door security kit, operator always located on left (viewed from inside), plastic housing. Micro-processor control in separate plastic housing, automatic teaching of auto safety cut-out and travel limits, soft start and soft stop, light, impulse control, adjustable automatic timer (hold-open time 30 sec. after activation, additional photocell required). Included: 2 hand transmitters and integral receiver, connecting lead with CEE plug, control buttons in cover of the control unit, integrated 2-minute garage light in control housing, quick release (operated from inside). Please note, a wired optical sensor is included as a mandatory safety feature for all GaraRoll doors over 5000 mm wide.

Windows

Window size approx. 120 x 40 mm, number of windows per door section depends on door width. Windows made of clear synthetic pane with black window frame on exterior, transparent frame on interior. Maximum of 10 window sections per door.

Window arrangement:

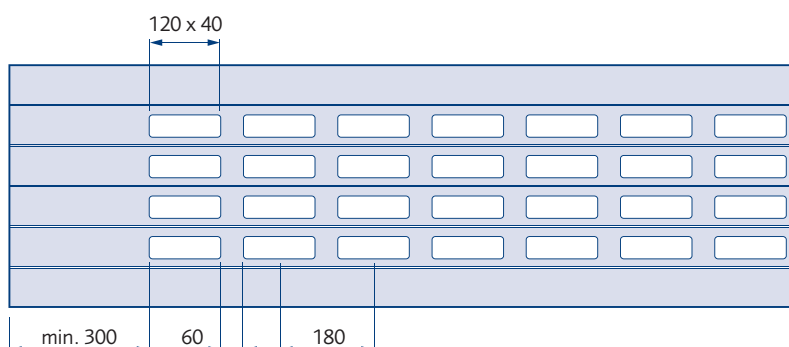

Packaging

GaraRoll doors are supplied in a palletted format shrink wrapped as a complete package.

Stock availability

All GaraRoll doors are made to order with no standard sizes. Lead-time for all doors is 3 to 4 weeks.

Remember the GaraRoll door is measured as opening size and not as overall guide width.

This not only makes it the same as all other Garador doors for sizing but also will probably reduce the price against other doors as most other door manufacturers calculate the price as over guide width thus making the actual door around 220 mm smaller!

Minimum product dimension is 1000 mm x 1600 mm.

■ Only the door prices highlighted are available with the external roller garage door fitting as an option.

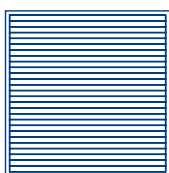

Smooth paint finish

Door width

Door height	1000	1250	1500	1750	1900	2000	2250	2500	2750	3000	3250	3500	3750	4000	4250	4500	4750	5000	5250	5500	5750	6000	
1600																							
1800		2502	2502	2592	2592	2617	2756	2848	2943	2982	3218	3313	3706	3792	3957	4044	4138	4230	4536	4630	4723	4815	
2000		2502	2502	2592	2592	2617	2756	2848	2943	2982	3218	3313	3706	3792	3957	4044	4138	4230	4536	4630	4723	4815	
2125		2502	2502	2592	2592	2709	2876	2921	2998	3080	3326	3431	3857	3893	4122	4213	4307	4398	4703	4795	4888	4979	
2250		2502	2502	2592	2592	2754	2961	3028	3092	3205	3489	3837	3982	4017	4235	4323	4416	4505	4811	4900	4987	5076	
2375		2502	2502	2592	2592	2754	2961	3028	3092	3205	3489	3837	3982	4017	4235	4323	4416	4505	4811	4900	4987	5076	
2500		2669	2669	2809	2809	2847	3009	3104	3217	3305	3602	3979	4053	4208	4375	4468	4558	4647	4953	5039	5130	5219	
2625		2669	2669	2809	2809	2938	3094	3191	3308	3428	3965	4126	4267	4409	4517	4611	4699	4788	-	-	-	-	
2675		2669	2669	2809	2809	2938	3094	3191	3308	3428	3965	4126	4267	4409	4517	4611	4699	4788	-	-	-	-	
2750		-	-	-	-	2938	3094	3191	3308	3428	3965	4126	4267	4409	-	-	-	-	-	-	-	-	
2875		-	-	-	-	2977	3224	3305	3406	3489	4078	4216	4385	4471	-	-	-	-	-	-	-	-	
3000		-	-	-	-	2977	3224	3305	3406	3489	4078	4216	4385	4471	-	-	-	-	-	-	-	-	
3100		-	-	-	-	2977	3224	3305	3406	3489	4078	4216	4385	4471	-	-	-	-	-	-	-	-	

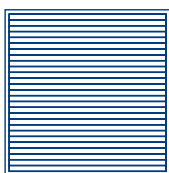

Deco paint finish

Door width

Door height	1000	1250	1500	1750	1900	2000	2250	2500	2750	3000	3250	3500	3750	4000	4250	4500	4750	5000	5250	5500	5750	6000	
1600																							
1800		2562	2576	2681	2696	2730	2875	2982	3091	3145	3396	3506	3914	4014	4194	4296	4405	4512	4832	4941	5049	5156	
2000		2569	2586	2692	2709	2744	2890	2998	3110	3166	3418	3530	3940	4042	4224	4328	4438	4547	4869	4980	5090	5198	
2125		2576	2595	2703	2722	2850	3024	3088	3183	3284	3548	3672	4116	4171	4418	4528	4640	4750	5073	5184	5295	5405	
2250		2581	2601	2710	2730	2904	3119	3205	3289	3422	3725	4093	4258	4312	4550	4658	4770	4879	5205	5313	5420	5529	
2375		2586	2607	2717	2738	2913	3128	3216	3301	3434	3739	4108	4274	4330	4568	4677	4791	4901	5228	5338	5445	5555	
2500		2757	2779	2941	2963	3014	3185	3302	3437	3547	3866	4265	4361	4538	4727	4842	4954	5065	5393	5501	5614	5725	
2625		2762	2785	2948	2971	3114	3279	3400	3540	3683	4243	4427	4591	4756	4887	5005	5116	5228	-	-	-	-	
2675		2767	2791	2955	2979	3123	3289	3410	3551	3696	4257	4442	4607	4774	4906	5024	5137	5250	-	-	-	-	
2750		-	-	-	-	3127	3292	3414	3556	3701	4262	4448	4614	4781	-	-	-	-	-	-	-	-	
2875		-	-	-	-	3171	3428	3534	3661	3769	4384	4547	4742	4853	-	-	-	-	-	-	-	-	
3000		-	-	-	-	3180	3437	3545	3672	3782	4398	4562	4758	4870	-	-	-	-	-	-	-	-	
3100		-	-	-	-	3188	3446	3555	3684	3795	4411	4577	4774	4888	-	-	-	-	-	-	-	-	

Deco paint only available in Golden Oak, Anthracite Metallic (Noir 2100 Sable) or Rosewood finish.

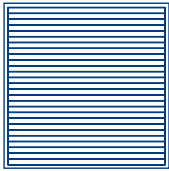

Timber effect finish

Door height	Door width																						
	1000	1250	1500	1750	1900	2000	2250	2500	2750	3000	3250	3500	3750	4000	4250	4500	4750	5000	5250	5500	5750	6000	
1600																							
1800	2613	2640	2758	2786	2827	2977	3097	3219	3286	3550	3672	4093	4206	4399	4514	4635	4755	5088	5210	5331	5450		
2000	2627	2658	2779	2810	2853	3005	3128	3254	3324	3591	3717	4141	4258	4454	4572	4697	4820	5157	5283	5407	5530		
2125	2640	2675	2799	2834	2972	3152	3232	3343	3460	3740	3880	4340	4411	4674	4800	4928	5054	5393	5520	5647	5773		
2250	2649	2686	2812	2849	3033	3255	3358	3459	3609	3929	4314	4496	4567	4822	4947	5076	5202	5545	5670	5794	5920		
2375	2658	2697	2825	2864	3049	3272	3378	3481	3632	3955	4342	4526	4600	4856	4983	5115	5243	5588	5716	5841	5969		
2500	2833	2874	3055	3096	3159	3337	3473	3627	3756	4094	4512	4627	4823	5031	5165	5296	5426	5773	5900	6032	6162		
2625	2842	2885	3068	3111	3266	3439	3580	3740	3903	4483	4687	4871	5056	5207	5345	5476	5608	-	-	-	-		
2675	2851	2896	3081	3126	3283	3457	3599	3761	3927	4509	4715	4901	5089	5242	5381	5515	5649	-	-	-	-		
2750	-	-	-	-	3289	3464	3607	3770	3936	4519	4726	4914	5102	-	-	-	-	-	-	-	-		
2875	-	-	-	-	3338	3604	3732	3881	4011	4648	4833	5050	5183	-	-	-	-	-	-	-	-		
3000	-	-	-	-	3354	3621	3752	3902	4035	4674	4861	5080	5215	-	-	-	-	-	-	-	-		
3100	-	-	-	-	3371	3638	3771	3924	4059	4699	4889	5110	5248	-	-	-	-	-	-	-	-		

Timber Effect Foil Coat only available in Golden Oak and Rosewood finish.

Options for GaraRoll doors

	add
Surcharge for different colour frame and guides to door colour	159
Manually operated version (not possible on external fit)	Price reduction 253
Removal of barrel casing (optional only on door height 2500 mm and over)	Price reduction per m 26
External fit (reverse rolled)	115
Chamfered bottom profile available only in White or Colour. Not available in timber effect finish	per m 332
Ventilation grilles or Glazing element with clear synthetic pane, window section 120 x 40 mm, black glazing frame on exterior, transparent on interior (maximum of 10 sections per door, number of glazing elements dependent on the door width) ¹	per m 42

¹ Not available in top 6 laths.

Accessories for GaraRoll operator

	add
Bi-directional hand transmitter, 5-channel in black	93
Bi-directional hand transmitter mini, 4-channel in black	79
Motor connection line, 10 m - Reference No. 5498	60
Acoustic door security kit - Reference No. 8671	99
Emergency battery HNA 18 - Reference No. 8126	282
Exterior emergency release - Reference No. 5501	152
Additional fascia panel required when fitting a door within the opening, ordering size will need to be door size plus guide width (price per metre) supplied in colour to match the door / guides	77

All other operator accessories can be combined with GaraRoll roller doors. Please see page 73 to page 76.

GaraRoll is also available with a colour door curtain and white guide rails and box cover, at an additional cost of £166.
If required, please state clearly on your order.

Roller door fitting dimensions

Fitting behind the opening

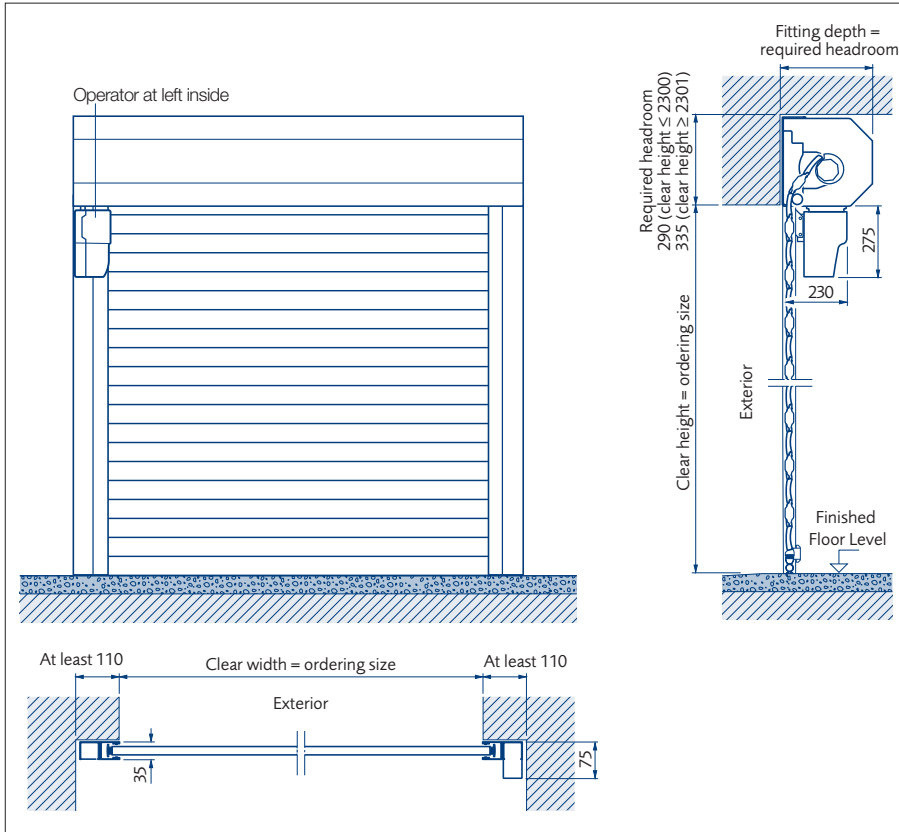

Clear passage width =
clear width (ordering size)

Clear passage height =
clear height (ordering size)
– 80 mm for automated version,
– 140 mm for manually operated version

Fitting in the opening

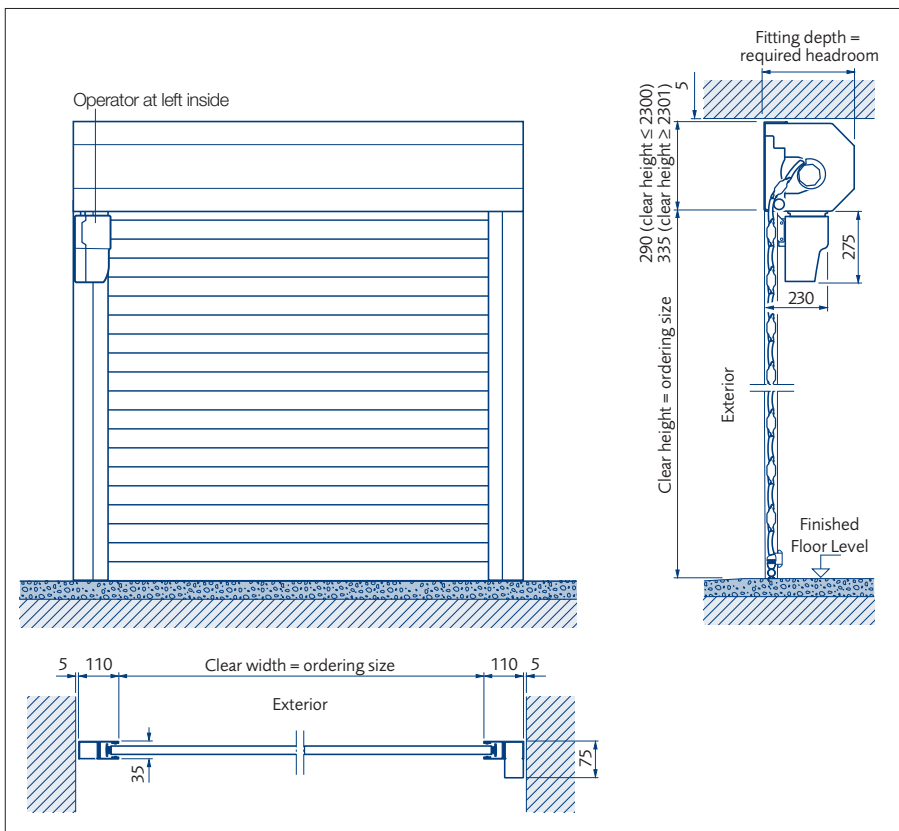

Clear passage width =
clear width (ordering size)

Clear passage height =
clear height (ordering size)
– 80 mm for automated version,
– 140 mm for manually operated version

GaraGlide Roller Doors

A motor driven, roller garage door with tubular drive motor, closing edge safety device and manual hand crank for emergencies. The emergency release kit is not available for a retro-fit application so must be ordered with the original door. All doors are built to suit the opening, with the actual door size relating to the structural opening width x height and the guides fitting on the reveals to maintain a full opening size. Please refer to sizing tables for full range of size options.

Door Curtain

77 mm rolled aluminium profile with 100 % CFC-free polyurethane rigid foam. Available in 16 standard colour, with a two-layer paint finish using a high-quality polyurethane paint coated with a polyimide. Each lath is 15 mm thick.

Frame and Construction

75 mm guide rails for single doors and 105 mm for double doors. Guide rails are supplied in a colour to match the door curtain and with an integrated brush strip either side. The box cover, rollers and barrel are pre-assembled for convenience. Please state on your order if fitting between or behind opening.

Operator and Control

GaraGlide operator and control included. 24 V DC gear drive, mains voltage 230 - 240 V AC, 0.5 KW, anti-lift kit, operator built into tubular drive with control board located on right as standard (viewed from inside) and impulse control. Operator with mechanically adjustable end-of-travel position. Included: 2 x bisecur 868 MHz hand transmitters and integral receiver, connecting lead with CEE plug, control buttons in cover of the control unit, integrated 2-minute garage courtesy light in control housing. The motor can be fitted either side. Also features an adjustable reversing procedure, adjustable pre-warning phase, adjustable automatic timer, connection of external illumination is possible and there is also a connecting option for a one-way photo cell.

Standard Colours

GaraGlide roller doors are available in a choice of 15 standard colours, with the door curtain interior and exterior painted the same colour:

- | | | | |
|----------------------------|------------------------------|--------------------------|------------------------------|
| - Traffic White (RAL 9016) | - Steel Blue (RAL 5011) | - Light Grey (RAL 7035) | - White Aluminium (RAL 9006) |
| - Light Ivory (RAL 1015) | - Moss Green (RAL 6005) | - Terra Brown (RAL 8028) | - Grey Aluminium (RAL 9007) |
| - Ruby Red (RAL 3003) | - Slate Grey (RAL 7015) | - Cream (RAL 9001) | - Chartwell Green |
| - Purple Red (RAL 3004) | - Anthracite Grey (RAL 7016) | - Jet Black (RAL 9005) | |

Anthracite Metallic (Noir 2100 Sable) is also available at an additional cost. See page 83 for additional colour options.

Timber Effect Colours

A timber effect version is available in Golden Oak or Rosewood effect, where the exterior door curtain is coated in a UV-resistant synthetic foil with a timber effect design and embossed grain, and the interior of the door curtain is painted in Terra Brown (RAL 8028). A Deco Paint version is also available at a lower cost, where the laths are painted in a Golden Oak or Rosewood effect.

Fitting

The GaraGlide is suitable for fitting between and behind a prepared brickwork opening.

Packaging

GaraGlide roller doors are supplied in two twin-walled cardboard boxes for ease of transportation to site.

Stock Availability

All GaraGlide doors are made to order with no standard sizes. Lead-time for all doors is 4 weeks.

Size range

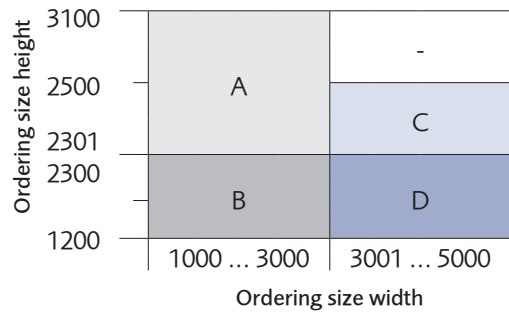

- A** Box 335, 75 mm guide rail, 70 mm shaft, no wind locks.
- B** Box 290, 75 mm guide rail, 70 mm shaft, no wind locks.
- C** Box 335, 105 mm guide rail, 80 mm shaft, with wind locks.
- D** Box 290, 105 mm guide rail, 80 mm shaft, with wind locks.

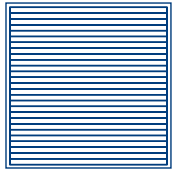

Smooth paint finish

Door height	Door width																	
	1000	1250	1500	1750	1900	2000	2250	2500	2750	3000	3250	3500	3750	4000	4250	4500	4750	5000
1200																		
1500	2123	2174	2200	2250	2250	2300	2348	2396	2466	2833	2883	2933	2977	3027	3090	3137	3189	
1750	2159	2211	2247	2303	2303	2359	2414	2470	2542	2920	2975	3027	3080	3137	3204	3257	3314	
2000	2184	2244	2289	2348	2348	2406	2462	2520	2602	2987	3043	3104	3163	3221	3296	3351	3411	
2125	2195	2254	2300	2359	2359	2417	2480	2539	2617	3007	3068	3126	3189	3247	3322	3380	3444	
2250	2211	2277	2322	2384	2384	2447	2514	2575	2656	3051	3115	3177	3241	3302	3380	3444	3505	
2375	2240	2307	2359	2423	2423	2496	2562	2630	2716	3115	3180	3247	3314	3481	3561	3627	3698	
2500	2250	2318	2372	2440	2440	2505	2579	2647	2735	3137	3207	3274	3346	3511	3594	3665	3730	
2625	2289	2363	2420	2496	2496	2572	2647	2720	2816	3224	3299	3373	3448	3536	3601	3692	-	
2675	2289	2363	2420	2496	2496	2572	2647	2720	2816	3224	3299	3373	3448	3536	3601	-	-	
2750	2289	2363	2420	2496	2496	2572	2647	2720	2816	3224	3299	3373	3448	3536	3601	-	-	
2875	2322	2406	2470	2546	2546	2630	2708	2790	2894	3411	3487	3569	3650	3746	-	-	-	
3000	2322	2406	2470	2546	2546	2630	2708	2790	2894	3411	3487	3569	3650	-	-	-	-	
3100	2322	2406	2470	2546	2546	2630	2708	2790	2894	3411	3487	3569	3650	-	-	-	-	

Additional Colour Options

Standard colours (choice of 15 colour options)	Included	
Anthracite Metallic (Noir 2100 Sable)	per m ²	39
Deco Paint (painted timber effect design in Golden Oak or Rosewood)	per m ²	39
Timber effect (plastic film coating in Golden Oak or Rosewood timber effect)	per m ²	70

Add £69 surcharge for external fit GaraGlide roller door.

Add £166 surcharge, to request the door curtain in one colour and the guide rails/box cover in an alternative colour. Please note there is no additional charge for a white frame.

Example of paint cost calculation:

For door dimensions of 2000 mm x 2125 mm, the door area is 4.25 m² (i.e. 2 x 2.125 = 4.25).

Multiply door area by cost per m² to calculate additional paint cost (i.e. 4.25 x 39 = £165.75).

Please note, dark colours should not be used for doors that are exposed to the sun. Despite the use of state-of-the-art colour coating systems, we cannot rule out colour deviations, specifically in metallic colours (RAL 9006 and RAL 9007).

Please state on your order if fitting between or behind opening.

External fit GaraGlide roller doors are only available up to 5000 mm wide and are not available in a timber effect finish.

GaraGlide is also available with a colour door curtain and white guide rails and box cover, at no extra charge. If required, please state clearly on your order.

Roller door fitting dimensions

Fitting behind opening

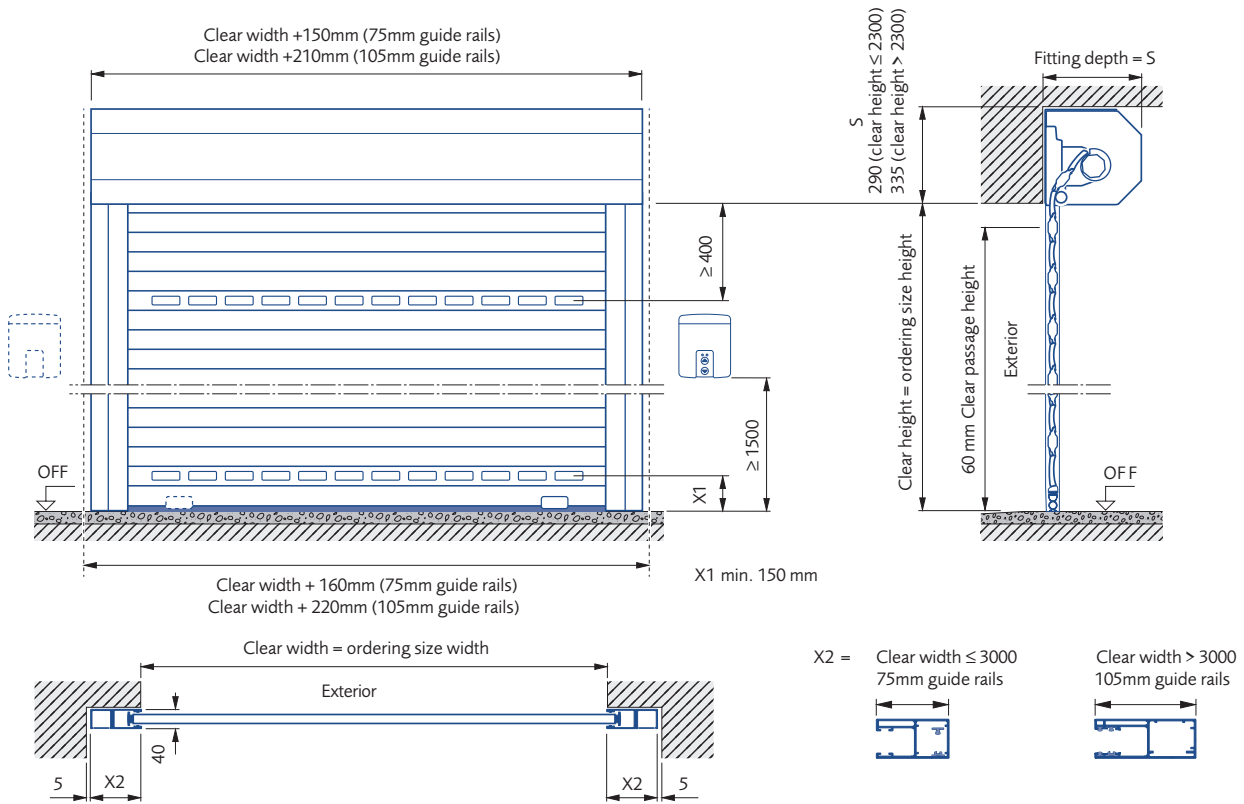

Fitting between opening

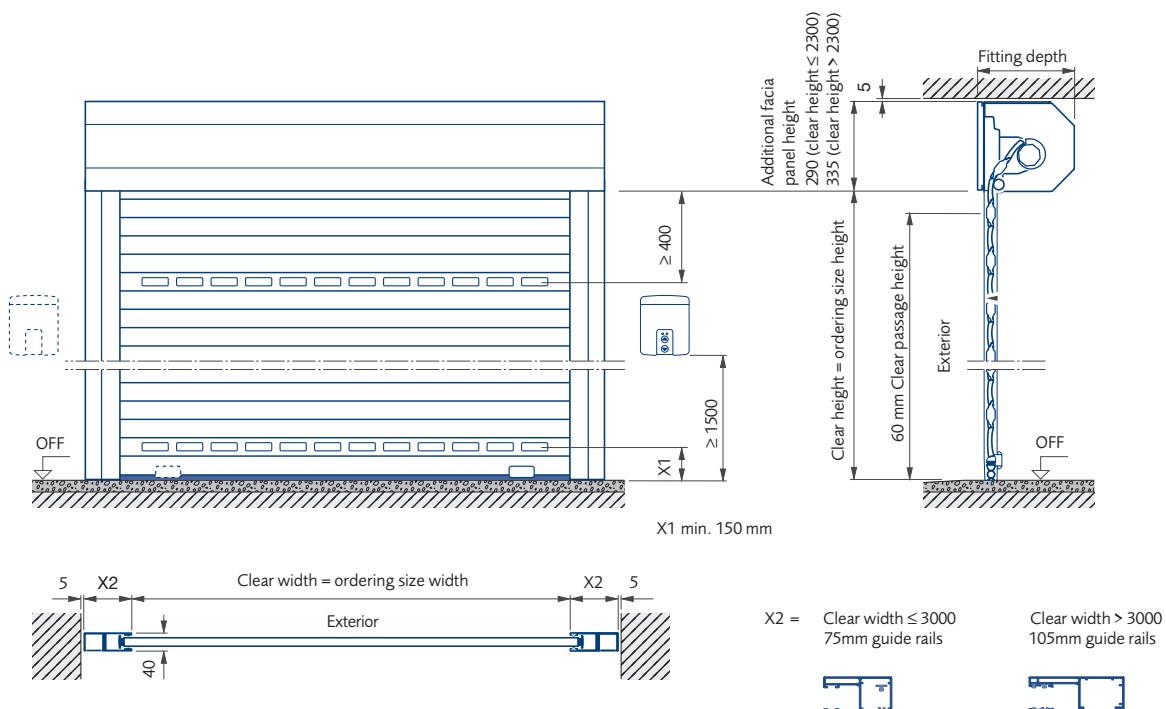

Options for all GaraGlide roller garage doors

Emergency Release

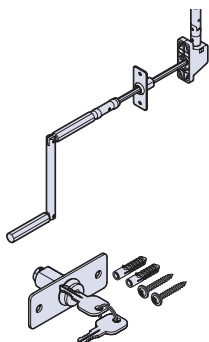

Exterior emergency release kit
(Please note: the emergency release kit is not available for a retro-fit application so must be ordered with the original door).

each

277

Ventilation Grilles and Glazing Elements



Glazing element (clear synthetic pane, window cut-out 112 mm x 33 mm)

per m

39



Ventilation grilles (black plastic with ventilation cross section approx 13 cm² / grille)

per m

39

Additional Fascia Panel

Reinforcement of the fascia panel (required for fitting between opening)

per m

99

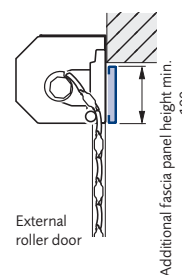
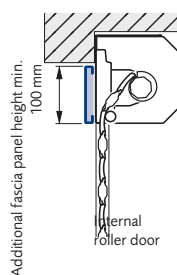
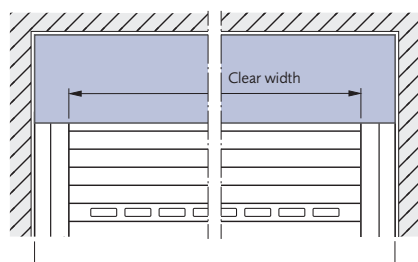
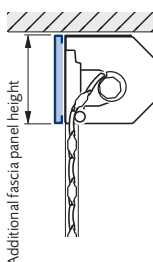
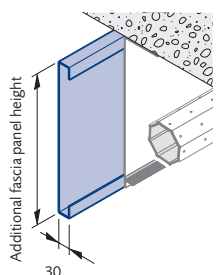

External fit (reverse rolled)

69

Operator with electronically adjustable end-of-travel positions

432

Wireless optical sensor

236

DuraBelt is available as an option when purchased with a new GaraGlide, or for retro-fitting to an existing GaraGlide:

DuraBelt (Optional)

1000 mm - 1600 mm wide (2 winding units)	surcharge per door	90
1601 mm - 3000 mm wide (3 winding units)	surcharge per door	134
3001 mm - 5000 mm wide (5 winding units)	surcharge per door	223

DuraBelt (Retro-Fitted)

up to 2300 mm wide (2 winding units)	per door	136
up to 2300 mm wide (3 winding units)	per door	204
from 2301 mm wide (2 winding units)	per door	136
from 2301 mm wide (3 winding units)	per door	204

User Information / Care

A Garador garage door needs only a minimum level of preparation and maintenance to give years of trouble-free service. Below is a guide to how to get the best from your garage door.

Operation

- For opening the door in manual operation use only the outside handle or inside handle. Never use the pull rope during the opening cycle of the door.
- For closing the door from the outside – the pull rope fixed to the internal handle is only designed to pull the door towards you whilst standing within the entrance of the garage until the door can be pushed down by hand, then using the external handle for final closing.
- For closing the door from the inside – the pull rope already mentioned is designed to be pulled away from you, when facing the front entrance of the garage, until the internal handle is able to be reached, by hand, and used for final closing. The pull rope is not designed to be used for any other part of the operating cycle, or any other purpose. Failure to comply with the above instructions may result in injury to persons or property.
- When the door is operated from either outside or inside, check the area through which the door will travel is clear from people and objects. Failure to do so may result in injury to persons or property.
- When closing, ensure the latches engage properly.
- If the door is power-operated always try to ensure you match the door with a GaraMatic electric operator.

Power Operated Garage Doors

- It is against the Law to install a power operated garage door in the UK without complying with The Machinery Directive.
- To comply with the Machinery Directive both the door and the operator used in the Installation must have a declaration of Incorporation from the manufacturer.
On completion of the installation the Installer must provide a Declaration of conformity and apply a CE mark giving details of the installation to the door/operator combination, which is now classed as a machine.
- The Installer must issue to the Customer a declaration of conformity on the completion of the installation.
- The Installer must hold copies of both the Declarations of Incorporation and the Declaration of Conformity on a technical file for inspection by the relevant authorities.
- If any of the above requirements are not fulfilled the Installation is illegal.
- Please ensure for your own safety and peace of mind that whoever installs your electric operator is both willing and able to fulfil these requirements; if they are not do not use them !!
- Members of the DHF CAN and WILL install your operator safely and legally.

Cleaning

- The door and frame if applicable, should be washed with a mild soap-based solution on a regular basis to prevent the build up of dirt, salts and other corrosive substances and help maintain the aesthetic appearance of the product.
- If the door is installed in a coastal location, the door panel and frame should be cleaned in this way at least every two months.
- We also suggest that all other components be brushed down on a regular basis to prevent the build up of dirt and dust etc.
- On GaraRoll roller doors regular removal of dirt and debris is required to avoid damage to laths when the curtain rolls.

Locking

- If the key is turned completely, the door is then locked or unlocked; when unlocked it is then possible to open and close the door by turning the handle.
- If the key is turned 1/4 of the way, the door opened and then the key returned to its start position, the door will re-lock when closed.
- By moving the internal locking "snib", it is possible to lock and unlock the door from the inside without using the key, except on SBD doors where there is no internal snib/locking system.

Maintenance

- If in doubt about any of these maintenance procedures below always consult a Garador specialist. Garador Ltd. has a nationwide network of installers who will be able to offer you a regular maintenance service on your garage door. Please call Garador or refer to the Garador website for further details of your nearest installer.
- Immediately after the door is fitted and after every 5,000 operations of the door, or at least once a year, oil all pivot points, check screws and clamped connections for tightness, keep the running tracks clean (do not grease them), check parts and replace any worn components where necessary.
- The springs should be replaced after approx. 25,000 operations by an experienced door fitter (see fitting and operation instructions).
- Do not oil the lock cylinder; if it is sticking, only lubricate with graphite dust.
- For canopy doors only, check the cable every 6 months with normal usage (8 operations per day). Have the cables replaced by an expert if any wear is found.

Finish – Steel Doors

The coating process applied to the door and chassis is environmentally friendly. Minor scratches or marks are not covered under the conditions of our warranty and should be repaired immediately to prevent corrosion and deterioration of the panel. Corrosive substances such as acids, alkalines, and salts, etc. should be cleaned from the door immediately; failure to do so will result in deterioration of the finish, which will not be covered under our warranty. Garador steel doors are finished products. They do not require immediate painting on-site. They are however not immune to damage, which can occur at any stage of the handling of the product from factory to site. Should deterioration of the finish start to occur you will need to repaint your door immediately. Prepare the surface lightly with wet and dry. Then treat with solvent based 2 pack epoxy wash primer and a normal commercial paint (cellulose paint must not be used).

Minor surface damage can easily be repaired using touch up sprays or paint sticks without invalidating your warranty.

Finish – Timber Doors

Timber panels are coated with a neutralising base-stain. Doors must be stored upright, under cover in a dry location, with wrapping intact, until wrapping is removed. As soon as the door is unwrapped, one coat of a good quality basecoat primer must be applied to both sides of the door. Immediately after installation, your timber doors require a further two coats of a good quality exterior wood finish on both sides.

Initial application and periodic treatment should be carried out strictly in accordance with the woodstain manufacturer's instructions.

Failure to follow these instructions will result in early deterioration of the timber panel which would not be covered under our warranty.

Finish – GRP Doors

GRP door panels should be periodically washed down using water. This should be done more frequently if fitted in a coastal location.

Bird droppings will bleach the finish on GRP and should be removed using water as soon as possible.

GRP doors should not be painted over.

Warranty

Garador products are manufactured to the highest quality standards and leave our factory only after rigorous quality testing. However, if you should have grounds for complaint, this section tells you what our door warranty offers, and how to go about making your claim.

In the unlikely event of a warranty claim becoming necessary, please contact the dealer or distributor who originally supplied your garage door. Your dealer should then supply details of the claim, together with a copy of the warranty card provided with the door and proof of purchase to the Warranty Department at Garador Ltd.

To enable your claim under warranty to be processed as quickly as possible, you should provide the following details:

- 1 Your name, address and telephone number
- 2 Original invoice with date of purchase
- 3 Product description/door type and product number
- 4 Description of defect

An assessment of the claim will then be made. This may require Garador to inspect the product in-situ. In the event that there is no legitimate warranty claim under the terms specified herein, you may be liable for the costs of the inspection visit. We strongly recommend that you take note of the care and usage instructions displayed on the stickers on the back of your garage door and on the previous page and that you follow these instructions throughout.

Garador installers

Garador Ltd. has a nationwide network of recommended installers who will be able to offer you a regular maintenance service on your garage door. Please call us on 01935 443722 or refer to the Garador website for further details of your nearest installer.

Garador Garage Door Warranty

Warranty Period

The purchaser is granted a warranty covering the safe and reliable function of the Garador garage door for a period of 10 years from the date of purchase. A 5 year warranty applies to springs, wire cables, track rollers, hinges and guide rollers. The warranty period for replacement parts is 6 months or to the end of the current warranty period, whichever is longer.

In the case of foil-coated timber effect and PVC doors, a warranty of 5 years is granted, for timber and GRP doors a warranty of 2 years is granted on the door panels alone under the terms and conditions specified herein. The door mechanism and steel frame (if applicable) is covered by the 10 year warranty period.

Requirements

Warranty claims are only applicable in the country where the garage door was purchased. The product must have been purchased through our authorised distribution channels. The warranty only covers damage to the contract object. The fully completed warranty card together with the receipt of purchase correspondingly dated substantiates your right to claim under the warranty.

Performance

During the warranty period we undertake to rectify any and all defects to the Garador product which can be proved to be attributed to a material or manufacturing fault.

We pledge at our discretion either to exchange the defective merchandise for faultless merchandise, repair it or allow a reduction in price. We do not accept costs for dismantling and installation nor for carriage.

Replaced parts become our property.

The warranty does not cover damage caused through:

- normal wear and tear
- improper installation
- negligent care and maintenance
- improper initial and subsequent operation
- negligent or wanton destruction
- external influences such as fire, water, salts, alkaline solutions, acids, abnormal environmental influences
- mechanical damage through improper transport and fitting
- priming and other surface protection treatments
- incorrect or too late applied surface protection treatments
- repair by non-qualified persons
- using non-Garador parts without the approval of the manufacturer
- Removal of the product number or making it unidentifiable

Warranty GaraRoll and GaraGlide

GaraRoll and GaraGlide roller doors are subject to a limited 10 year warranty. The design of these doors represents state of the art technology. Pressure marks and abrasive wear, particularly on the top profiles are a condition of the design and cannot be avoided. They are not considered a reason for complaint.

In order to avoid excessive friction, remove any dirt and debris from the door curtain at regular intervals. For motors and controls, see warranty below.

In addition to the statutory warranty provided by the dealer in the sales contract, we grant the following warranty for parts from the date of purchase:

- 5 years on operator technology, motor and motor control.
- 2 years on radio equipment, accessories and special systems.

Claims made under the warranty do not extend the warranty period. For replacement parts and repairs the warranty period is six months or at least the remainder of the warranty period.

General wear and tear:

Due to the design of the roller door, the inside of the door curtain will exhibit some marks after a short period of time. This is classed as general wear and tear that you would expect to see over a period of months or years. It is not detrimental to the door's performance and would therefore not be grounds for a warranty claim.

Pre-requisites:

The warranty claim only applies in the country where the equipment was purchased. The product must have been purchased through our authorised distribution channels. A claim under this warranty exists only for damage to the object of the contract itself. The receipt of purchase substantiates your right to claim under the warranty.

Services:

For the duration of the warranty we shall eliminate any product defects that are proven to be attributable to a material or manufacturing fault. We pledge to replace free of charge and at our discretion the defective goods with non-defective goods, to carry out repairs, or to grant a price reduction. Replaced parts become our property. Reimbursement of expenditure for dismantling and fitting, testing of parts as well as demands for lost profits and compensation for damages are excluded from the warranty.

Damage caused by the following is also excluded:

- improper fitting and connection
- improper initial start-up and operation
- external factors such as fire, water, abnormal environmental conditions
- mechanical damage caused by accidents, falls, impacts
- negligent or intentional destruction
- normal wear or deficient maintenance
- repairs conducted by unqualified persons
- use of non-original parts
- removal or defacing of the data label

Electric Operator Warranty

A separate 5 year warranty is granted on our electric operators. This includes operator mechanics, motor and motor control systems. A 2 year warranty is granted on radio equipment, accessories and system controls. There is no warranty on consumables (e. g. fuses, batteries, bulbs etc.). For further details please contact us on 01935 443722, or through our website on www.garador.co.uk

Extracts from DHF consumer advice

The following document has been created by the Door and Hardware Federation (DHF) and endorsed by all major UK garage door manufacturers, as a guide for purchasers and domestic garage doors.

Visual Appearance of Garage Doors

A new garage door can be a significant investment that will transform the appearance of your home. This information is a guide to the quality you can expect.

The Quality Check

The quality check should be carried out in natural daylight, not direct sunlight. Stand at a distance of 3 metres from the door to view the overall appearance. The door is acceptable if, taking into account the facts below, none of the following are readily visible on the face of the door:

- Marks or distortion associated with the manufacturing process
- Minor indentations, marks or scuffs on the surface
- Paint or stain blemishes

The Facts

Steel Doors

- Panel Distortion

The rolling or pressing of steel panels during manufacture will cause distortion in the steel and while every effort is made to keep this to a minimum, inevitably some visible distortion will remain. The application of high gloss paints will make this slight distortion more apparent, especially under certain lighting conditions, such as car headlamps, or bright sunshine.

- Paint Finish

Primed doors – the primer coating is applied as a base coat only and as such requires additional finishing with a good quality exterior paint.

Any marks or scratches on the primer coat should be rubbed down and repainted as part of this finishing process.

Finished doors – the factory application of the paint finish is an automated process and this may result in minor blemishes or slight inconsistencies in the paint, particularly in the area of panel joints.

Timber Doors

- Timber

Timber is a natural product and there will be variations in pattern, colour, shading and grains. No two doors will be the same. Wood naturally expands and contracts according to environmental conditions, joints will open and close and some minor curvature may occur.

- Finishing

It is vital that timber doors are fully finished as per the manufacturers instructions before exposure to the elements.

GRP and composite Plastic Doors

- Mould Marks

GRP doors are individually handcrafted in a mould and are then hand finished. Some minor marks and blemishes will inevitably remain after this process.

- Translucency

When viewed from the inside, it is often possible to see variations in the translucency of the door, particularly around and between areas of relief. Such variations do not detract from the overall strength or build quality of the door.

All Doors

- Colour Match

Pairs of doors should be ordered together to obtain the best colour match, bearing in mind the limitations of the materials used in the construction.

Timber garage doors cannot be ordered as matching sets.

- Size Variations

As the size of a door changes in height and/or width, the panel frequency and profile can change, therefore doors of the same style but of different sizes can be significantly different in appearance.

- Clearances

All doors require operating clearances, i.e. the gap between the door panel and the frame opening, these are inbuilt during manufacture and should not be reduced by means of infills, or draughtproofing.

- Deflection

When in the open position, all doors will display a level of vertical deflection or 'sag' across the width of the panel. Individual manufacturers' specifications should be consulted for exact tolerances.

GARADOR

The Garage Door People

Bunford Lane, Yeovil, Somerset, BA20 2GL
Tel: (01935) 443722 Fax: (01935) 443744

www.garador.co.uk



Garador is the UK's leading manufacturer of garage doors and operators, with an ultra-modern production facility located in Somerset. We use German engineering expertise to produce highly sophisticated doors and operators. By purchasing a Garador product you can be assured of the highest level of quality, safety and security. With a nationwide network of stockists, installers and service technicians we are an ideal partner for your project.